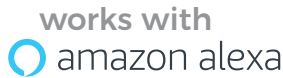

TABLE OF CONTENTS

ENGLISH.....	5-16
FRENCH.....	17-27
GERMAN.....	28-38
BULGARIAN.....	39-49
CROATIAN.....	50-60
PORTUGUESE.....	61-71
SPANISH.....	72-82
HUNGARIAN.....	83-93
ITALIAN.....	94-104
GREEK	105-115
POLISH	116-126
ROMANIAN.....	127-137
CZECH.....	138-148

INSTALLATION INSTRUCTION SMART DOME LIGHT



INTRODUCTION & WARRANTY

Thank you for selecting and buying V-TAC SMART LED Lighting. V-TAC will serve you the best. Please read these instructions carefully before starting the installing and keep this manual handy for future reference. If you have any another query, please contact our dealer or local vendor from whom you have purchased the product. They are trained and ready to serve you at the best. The warranty is valid for 2 years from the date of purchase. The warranty does not apply to damage caused by incorrect installation or abnormal wear and tear. The company gives no warranty against damage to any surface due to incorrect removal and installation of the product. The products are suitable for 10-12 Hours Daily operation. Usage of product for 24 Hours a day would void the warranty. This product is warranted for manufacturing defects only.

Multi-Language Manual - QR CODE

Please scan the QR code to access the manual in multi languages.



(FR) INTRODUCTION & GARANTIE

Merci d'avoir choisi et acheté un produit à V-TAC. V-TAC vous offrira le meilleur. Veuillez lire attentivement ces instructions avant de commencer l'installation et conservez ce manuel à portée de main pour référence ultérieure. Si vous avez d'autres questions, veuillez contacter notre distributeur ou le fournisseur local auprès duquel vous avez acheté le produit. Ils sont formés et prêts à vous servir au mieux. La garantie est valable pour une période de 2 ans à compter de la date d'achat. La garantie ne s'applique pas à des dommages causés par une installation incorrecte ou une usure anormale. La société ne donne aucune garantie pour des dommages causés à une surface en raison d'un enlèvement et d'une installation incorrects du produit. Les produits sont convenables pour une exploitation quotidienne de 10-12 heures. L'utilisation du produit pendant 24 heures par jour annule la garantie. Ce produit est couvert par une garantie pour des défauts de fabrication seulement.

(DE) INFÜHRUNG UND GEBRAUCHSANWEISUNG

Wir danken Ihnen, dass Sie ein V-TAC ausgesucht und gekauft haben. V-TAC wird Ihnen die besten Dienste erweisen. Lesen Sie, bitte, diese Gebrauchsanweisung vor der Montage aufmerksam durch und halten Sie sie für Auskünfte in der Zukunft parat. Sollten Sie weitere Fragen haben, kontaktieren Sie, bitte, unseren lokalen Händler oder Verkäufer, von dem Sie das Produkt gekauft haben. Sie sind ausgebildet und bereit Sie auf die bestmögliche Art und Weise zu unterstützen. Die Gewährleistungsfrist beträgt 2 Jahre ab dem Kaufdatum. Die Gewährleistung bezieht sich nicht auf Schäden, die durch unsachgemäße Montage oder ungewöhnliche Abnutzung und Verschleiß verursacht worden sind. Das Unternehmen gewährt keine Garantie für durch unsachgemäßen Produktabbau oder unsachgemäße Montage entstandene Schäden an jeglichen Oberflächen. Die Produkte sind für eine Nutzung von bis zu 10-12 Stunden täglich geeignet. Eine tägliche, 24-stündige Nutzung schließt die Gewährleistung aus. Diese Gewährleistung gilt nur für Herstellungsmängel.

(BG) ВЪВЕДЕНИЕ И ГАРАНЦИЯ

(V-TAC) ще ви послужи по най-добрия възможен начин. Моля прочетете тези инструкции внимателно преди инсталация и съхранявайте ръководството за бъдещи справки. Ако имате други въпроси, моля свържете се с нашия дилър или с местния търговец, от който сте закупили продукта. Те са обучени и са готови да ви послужат по най-добрия начин. Гаранцията е валидна за период от 2 години след датата на закупуване. Гаранцията не се прилага по отношение на щети, причинени поради неправилен монтаж или необичайно износване. Дружеството не предоставя гаранция срещу щети по каквато и да е повърхност поради неправилното отстраняване и монтаж на продукта. Продуктите са подходящи за 10-12 часа експлоатация на ден. Експлоатацията на продукт в продължение на 24 часа води до обезсилване на гаранцията. Гаранцията за този продукт се дава само за производствени дефекти.

(HR) UVOD I JAMSTVO

Hvala vam, što ste odabrali i kupili tvrtke Vi-Tek (V-TAC). Vi-Tek (V-TAC) će vam poslužiti na najbolji mogući način. Molimo, pažljivo pročitajte ove upute prije instalacije i spremite upute za buduću uporabu. Ako imate dodatnih pitanja, molimo obratite se našem prodavaču ili lokalnom trgovcu gdje ste kupili ovaj proizvod. Oni su osposobljeni i spremni vam pomognu na najbolji način. Jamstvo za ovaj proizvod vrijedi za razdoblje od 2 godine, računajući od dana kupnje. Jamstvo se ne odnosi na štetu, nastalu nepravilnom ugradnjom ili neuobičajenim habanjem. Tvrtka ne jamči za štete koje nastanu po bilo kojoj površini proizvoda, zbog nepravilne demontaže odnosno i ugradnje proizvoda. Ovi proizvodi su prikladni za 10-12 sati rada dnevno. Uporaba proizvod 24 sata dnevno čini ovo jamstvo nevažeće. Jamstvo za ovaj proizvod dano je samo za nedostatke koji su nastali samo tijekom njegove proizvodnje.

(PT) INTRODUÇÃO E GARANTIA

Agradecemos que escolheu e adquiriu o produto da V-TAC. A V-TAC irá servir-lhe da melhor maneira possível. Por favor, leia atentamente estas instruções antes da instalação e mantenha este manual para referência no futuro. Se tiver outras dúvidas, entre em contacto com o nosso revendedor ou comerciante local de quem adquiriu o produto. Eles são formados e estão prontos para lhe serem úteis da melhor maneira possível. A garantia é válida por um período de 2 anos a partir da data de compra. A garantia não se aplica a danos causados devido a uma instalação incorrecta ou desgaste invulgar. A empresa não dá nenhuma garantia por danos de qualquer superfície devido à inadequada remoção e instalação do produto. Os produtos são apropriados para exploração durante 10-12 horas por dia. A exploração do produto durante 24 horas leva à invalidação da garantia. Este produto tem uma garantia apenas para defeitos de fabricação.

(ES) INTRODUCCIÓN Y GARANTÍA

Le agradecemos que ha elegido y adquirido la V-TAC. V-TAC le servirá del mejor modo posible. Pedimos que antes de comenzar la instalación lea atentamente las presentes instrucciones y las guarde en un lugar adecuado para consultas próximas. En caso de dudas o preguntas, póngase, por favor, en contacto con el representante o suministrador más cercano de quien ha comprado el producto. Él será debidamente instruido y dispuesto para atenderle de la mejor manera posible. La garantía tendrá una duración de 2 años, contados a partir de la fecha de la compra. La garantía no será aplicable a daños ocasionados por instalación incorrecta o gasto inhabitual. La empresa no otorgará garantía para daños de superficies de cualquier tipo generados por su eliminación e instalación incorrectas. Los productos tendrán explotación adecuada durante unas 10-12 horas diarias. La explotación de 24 horas diarias llevará a la anulación de la garantía. La garantía cubrirá solo defectos de producción de fábrica.

(HU) BEVEZETÉS ÉS GARANCIA

Köszönjük, hogy választotta és megvásárolta a V-TAC terméket. V-TAC nyújtja Önnek a legjobb szolgáltatást. Kérjük, a szerelés előtt figyelmesen olvassa el ezeket az utasításokat és óvja ezt a kézikönyvet későbbi használatra. Ha további kérdései vannak, kérjük, forduljon forgalmazójához vagy helyi eladójához, akitől megvásárolta a terméket. Ők képzettek és készek a legjobb szolgálatra. A jótállás a vásárlás napjától számítva 2 évig érvényes. A garancia nem vonatkozik a helytelen szerelés vagy az abnormális kopás okozta károkra. A cég nem vállal semmilyen garanciát a felület károsodásáért, a termék helytelen eltávolításáért és szereléséért. A termékek 10-12 órás napi üzemeltetésre alkalmasak. A termék napi 24 órás felhasználása érvényteleníti a garanciát. Ez a termék garanciája csak a gyártási hibákra vonatkozik.

(IT) INTRODUZIONE E GARANZIA

Grazie per aver scelto e acquistato il prodotto della V-TAC. La V-TAC Le servirà nel miglior modo possibile. Si prega di leggere attentamente queste istruzioni prima di iniziare l'installazione e di conservare questo manuale a portata di mano per riferimenti futuri. In caso di qualunque altra domanda si prega di contattare il nostro rivenditore o il distributore locale da chi è stato acquistato il prodotto. Loro sono addestrati e pronti a servirla nel miglior modo possibile. La garanzia è valida per 2 anni dalla data d'acquisto. La garanzia non si applica ai danni provocati dall'installazione errata o dall'usura anomala. L'azienda non fornisce alcuna garanzia per danni a qualsiasi superficie a causa della rimozione e dell'installazione errata del prodotto. I prodotti sono adatti per 10-12 ore di funzionamento quotidiano. L'utilizzo del prodotto per 24 ore al giorno annulla la garanzia. La garanzia di questo prodotto è valida soltanto per difetti di fabbricazione.

(EL) ΕΙΣΑΓΩΓΗ - ΕΓΓΥΗΣΗ

Σας ευχαριστούμε για το ότι επιλέξατε και αγοράσατε το προϊόν της Βι-TAK(V-TAC). Η Βι-TAK (V-TAC) θα σας εξυπηρετήσει με τον καλύτερο δυνατό τρόπο. Παρακαλούμε να διαβάσετε προσεκτικά τις οδηγίες μας προτού τοποθετήσετε και διατηρήσετε τις οδηγίες για τη μετέπειτα ενημέρωσή σας. Αν έχετε άλλα ερωτήματα και απορίες, παρακαλούμε να έλθετε σε επαφή με τον προμηθευτή μας ή με τον εγγώριο έμπορο από τον οποίο αγοράσατε το προϊόν. Αυτοί εκπαιδεύτηκαν κατάλληλα και είναι πρόθυμοι να σας εξυπηρετήσουν με τον καλύτερο τρόπο. Η εγγύηση ισχύει για περίοδο 2 ετών από την ημερομηνία της αγοράς. Η εγγύηση δεν εφαρμόζεται σε περίπτωση που προκληθούν ζημιές εξαιτίας λάθος τοποθέτησης ή ασυνήθιστης φθοράς. Η εταιρεία δεν παρέχει εγγύηση για ζημιές σε οποιαδήποτε επιφάνεια εξαιτίας τις λάθος απομάκρυνσης ή τοποθέτησης του προϊόντος. Τα προϊόντα είναι κατάλληλα για χρήση 10-12 ωρών την ημέρα. Η χρήση του προϊόντος επί 24 ώρες έχει ως αποτέλεσμα την ακύρωση της εγγύησης. Η εγγύηση του προϊόντος αφορά μόνο τα ελαττώματα της παραγωγής.

(PL) WSTĘP I GWARANCJAD

Dziękujemy za wybór i zakup produktu V-TAC. V-TAC będzie Ci służył najlepiej. Proszę przeczytać tę instrukcję uważnie przed przystąpieniem do zainstalowania i zachować ją do użytku w przyszłości. Jeśli masz jakieś pytania, proszę skontaktować się z naszym Przedstawicielem lub z dystrybutorem, od którego kupiłeś produkt. Oni są przeszkoleni i gotowi udzielić Ci pomocy. Gwarancja ważna jest 2 lata od zakupu. Gwarancja nie obejmuje uszkodzeń wynikających z niewłaściwego zainstalowania lub nadzwyczajnego zużycia. Spółka nie ponosi odpowiedzialności za ewentualne szkody spowodowane na powierzchniach podczas instalacji lub deinstalacji. Łączny czas świecenia opraw w ciągu doby nie może przekroczyć 10-12 godzin, 24-godzinna eksploatacja produktu prowadzi do unieważnienia gwarancji. Gwarancja obejmuje jedynie wady powstałe z przyczyn tkwiących w produkcie.

(RO) INTRODUCERE, GARANȚIA

Vă mulțumim că ați ales și v-ați cumpărat acest produs de V-TAC. V-TAC vă va fi de un mare folos, utilizându-l în modul cel mai potrivit posibil. Vă rugăm să citiți aceste instrucțiuni cu atenție, înainte să începeți instalarea, și păstrați-le pentru că s-ar putea să fie necesar să le recitiți. Dacă aveți și alte întrebări, luați legătură cu dealer-ul nostru sau cu comerciantul de la care v-ați achiziționat produsul. Aceștia sunt bine instruiți și întotdeauna sunt disponibili să vă servească în modul cel mai bun posibil. Garanția este valabilă pe un termen de 2 ani din data achiziționării produsului. Garanția însă nu se aplică cu privire la daunele cauzate de instalare incorectă sau care rezultă din uzură anormală de utilizare. Societatea nu acordă garanție pentru daune produse pe suprafețe, indiferent de tipul acestora, care se datorează îndepărtării sau montării incorecte a produsului. Aceste produse sunt potrivite pentru exploatare continuă timp de 10-12 ore pe zi. Exploatarea produsului timp de 24 de ore fără întrerupere, poate duce la pierderea garanției. Pentru acest produs, garanția se acordă numai pentru defecte de fabricație.

(CZ) ÚVOD A ZÁRUKA

Děkujeme, že jste si vybrali a koupili výrobek firmy V-TEK (V-TAC). V-TEK (V-TAC) vám nabízí ty nejlepší výrobky. Před zahájením instalace si prosím pečlivě přečtete tyto pokyny a uschovejte si tento návod pro budoucí použití. Pokud máte další dotazy, obraťte se na našeho prodejce nebo místního obchodního zástupce, od kterého jste výrobek zakoupili. Oni jsou vyškoleni a jsou vám k dispozici pro všechny vaše potřeby. Záruka je platná po dobu 2 let od data zakoupení. Záruka se nevztahuje na škody způsobené nesprávnou instalací nebo atypickým opotřebením. Společnost neposkytuje záruku na poškození na jakémkoli povrchu kvůli neodbornému odstranění a instalaci výrobku. Výrobky jsou vhodné pro 10-12 hodin každodenní využívání. Používání výrobku během 24 hodin denně ruší platnost záruky. Výrobek má záruku pouze pro výrobní vady.

WARNING!

1. Please make sure to turn off the power before starting the installation.
2. The light source of this luminaire is not replaceable, when the light source reaches its end of life the whole luminaire should be replaced.
3. Install only by certified Electrician.



This marking indicates that this product should not be disposed of with other household wastes.



Caution, risk of electric shock.

INSTALLATION DIAGRAM

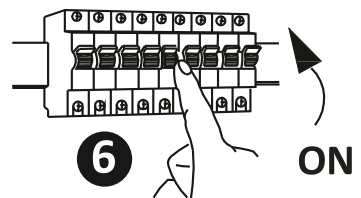
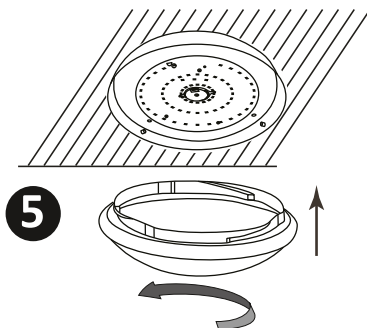
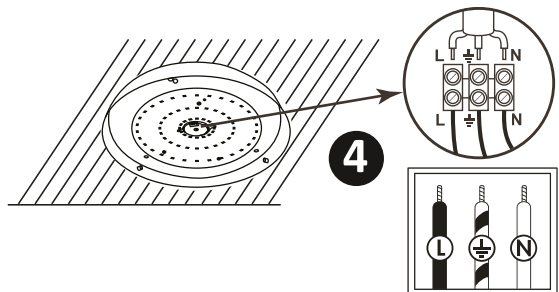
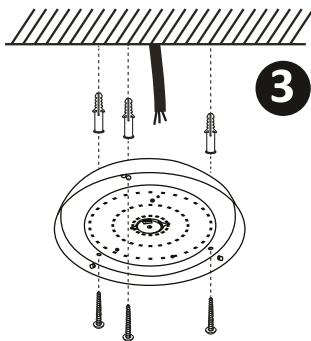
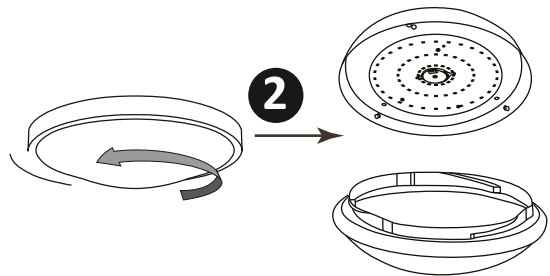
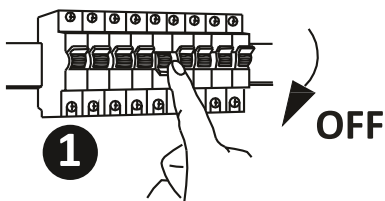

INSTALLATION INSTRUCTION

- 1) Switch Off the Power Before Starting the Installation (Ref Image No. 1).
- 2) Twist and remove the cover (Ref Image No. 2)
- 3) Drill Hole in the ceiling to fix the light using screws (Ref Image No. 3)
- 4) Connect the wires (Ref Image No. 4) before fixing the light using screws on the ceiling.
- 5) Twist and lock the cover to the light (Ref Image No. 5)
- 6) Switch ON the power and test the light

SAFETY WARNING

- 1) Luminaire are limited to indoor use and not advisable for use in humid environment
- 2) Luminaire cannot be installed on the surface of ordinary combustible materials.
Increase in temperature is normal for luminaire .
- 3) Do not exert external force or throw on the luminaire.
- 4) Luminaire should be stored in cool/dry place. Always make sure the environment is clean before installing the luminaire.
- 5) Do not discard the luminaire with regular trash. Luminaire are made with electronic components and should be properly disposed at designated locations with unified treatment like traditional electronic equipment.

APP INSTALLATION

Step1: Scan the given QR code, or download "V-TAC Smart Light" from the App Store (iOS) or the Google Play Store (Android).

For ANDROID



For IOS



Step2: Open the V-TAC Smart Light app and tap on register for creating a new account.

V-TAC Smart Light

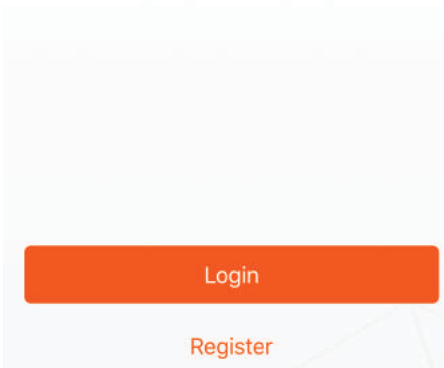

Step3:

A) Mobile Number: Select the country, then enter your mobile number. Once done, tap 'Next'.

B) E-Mail: Enter your email id and tap on 'Next'.

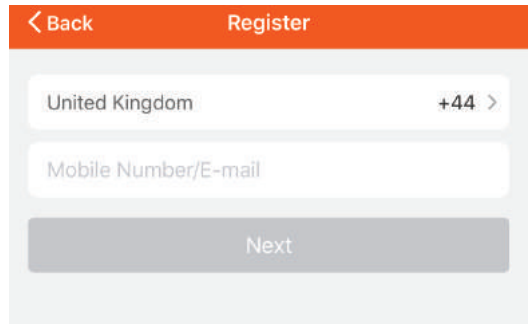

Step4: Enter the verification code which will be sent to your mobile number/email id, then assign a new password to your account and tap on "Confirm".

Step5: Tap on 'Add Device' or the + sign. Make sure the Smart device is switched on.

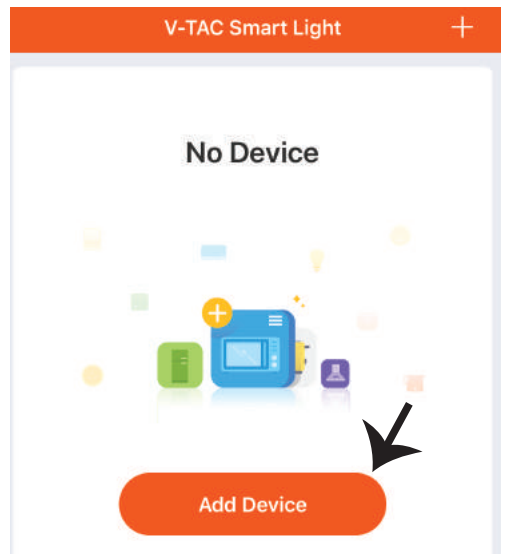
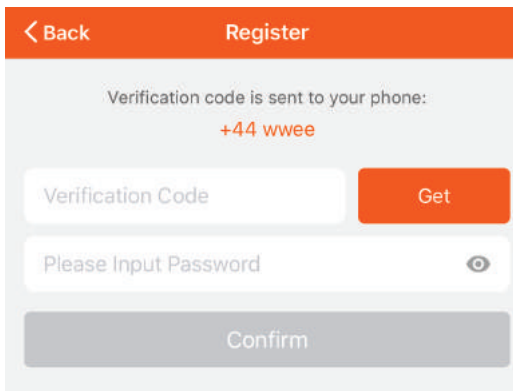

Step6: Choose 'Lighting Devices' to start pairing the Smart device with the app.

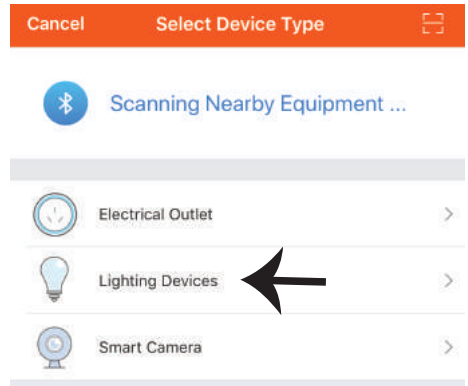

Step7: To pair the smart device with the App make sure the light is blinking rapidly.

Once the light blinks rapidly, the Smart device is in pairing mode. If the light is not blinking rapidly, you can do one of the following steps:

- A. Switch the light on & off repeatedly for 3 times, with short intervals of less than 2 seconds.
- B. Tap the 'How to make light blink rapidly' link (as shown on the image to the right)

Network Modes:

- 1) EZ Mode: Light flashes twice per second
- 2) AP mode: Slow flash, once every 2 second

Confirm if the light blinks rapidly, select the WiFi network, and enter the password.

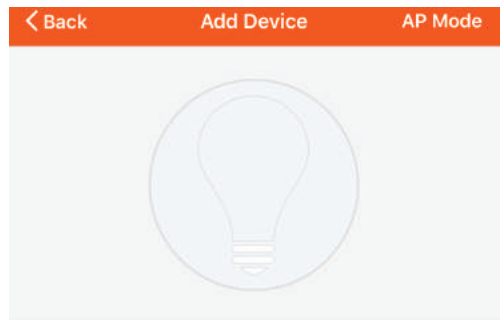

Power on the light and confirm that light blinks rapidly

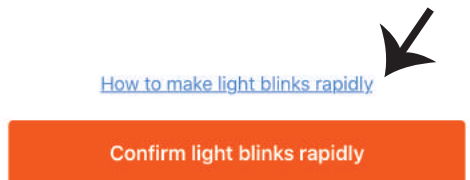
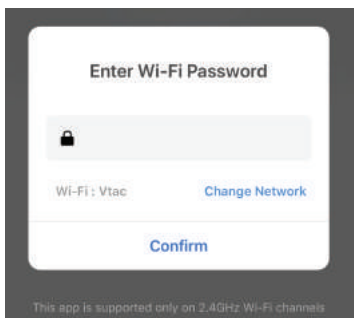

Step8: Once you have successfully completed step 9, you will be redirected to below page, where the App searches, registers and initializes the smart device (ref image below)

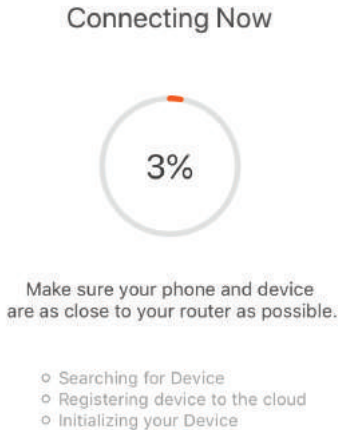

Step9: Once your device is successfully added, rename the device to your preference.

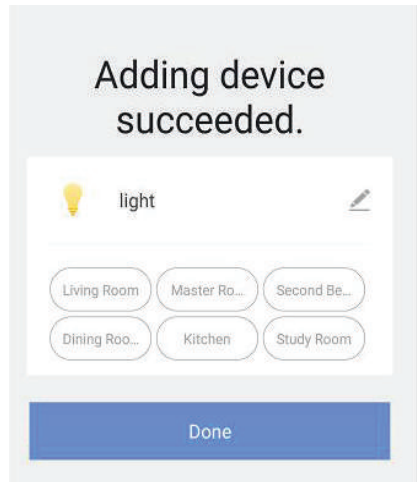

Step10: After successfully pairing the Smart device with the app, you can start controlling multiple features of the luminaire through your mobile– on/off switch, changing the colour temperature, timing & schedules, dimming options, and more.

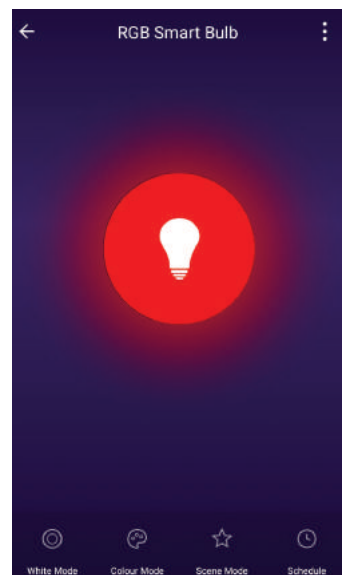
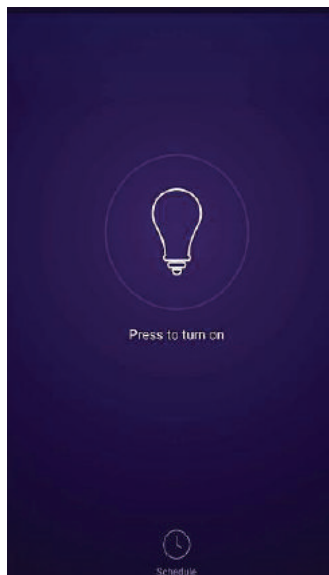
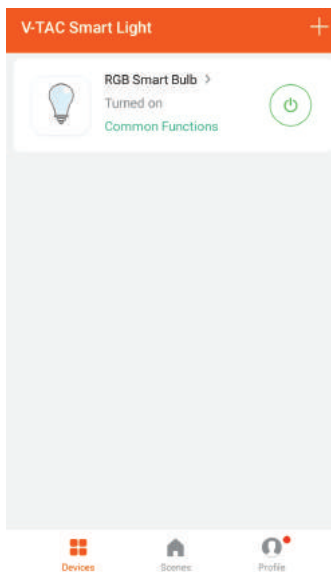

ALEXA SETTINGS

Step1: Install the Amazon Alexa app via the App Store (iOS) or the Play Store (Android) and register. If you already have an existing account with Amazon Alexa, please proceed to logging in.

Step2: Once you are on the Amazon Alexa home page, tap on the lower right icon — where the arrow is pointed — to add a new device and skill.

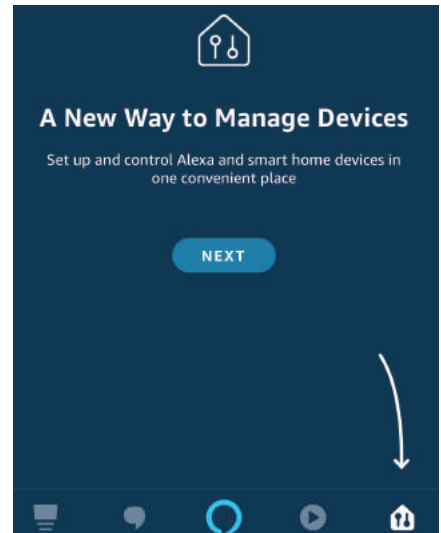

Step3: Tap on  settings and tap on “skills and games” as shown below.

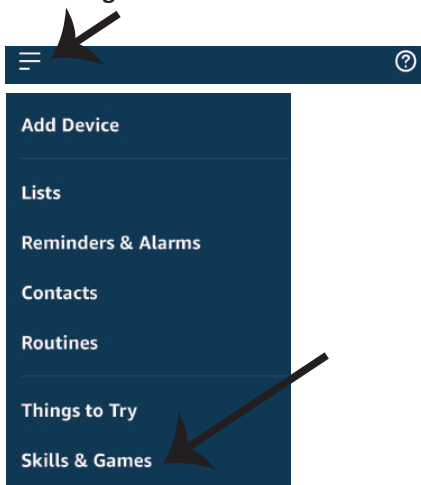

Step4: Search for ‘V-TAC Smart Light’ on the “Skills & Games” page as shown below.

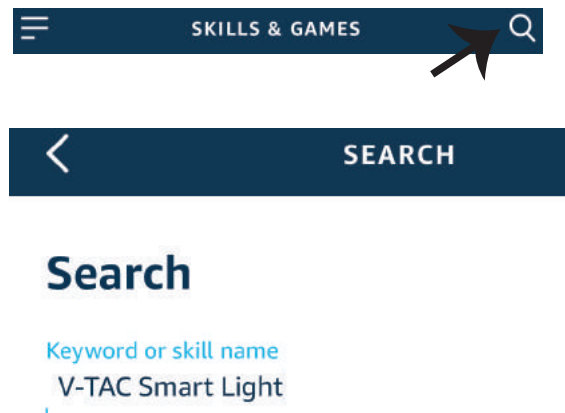

Step5: Enable the Skill.**Step6: Enter your V-TAC Smart Light login ID and password and tap on "Link Now"**

Step7: Once you tap on Link Now, you will be redirected to a new page requesting for authorization(Ref Image below). Tap on "Authorize"



Alexa by Amazon will be able to:

Receive your public profile
Control your devices over internet



Step8: You will receive confirmation of the account being linked successfully (Ref Image below)

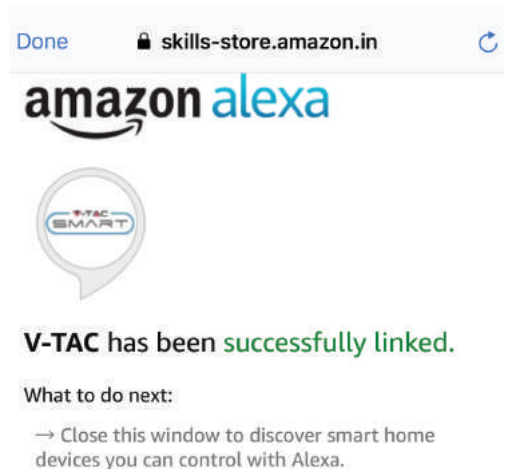

Step8: Discover your smart device on Alexa. Once you have enabled the skill

A) You can use voice command "Alexa discover devices" to the Alexa device which you have.

B) To add device manually on home page tap on  and tap on Add device , select the device which you are adding and tap on discover device.

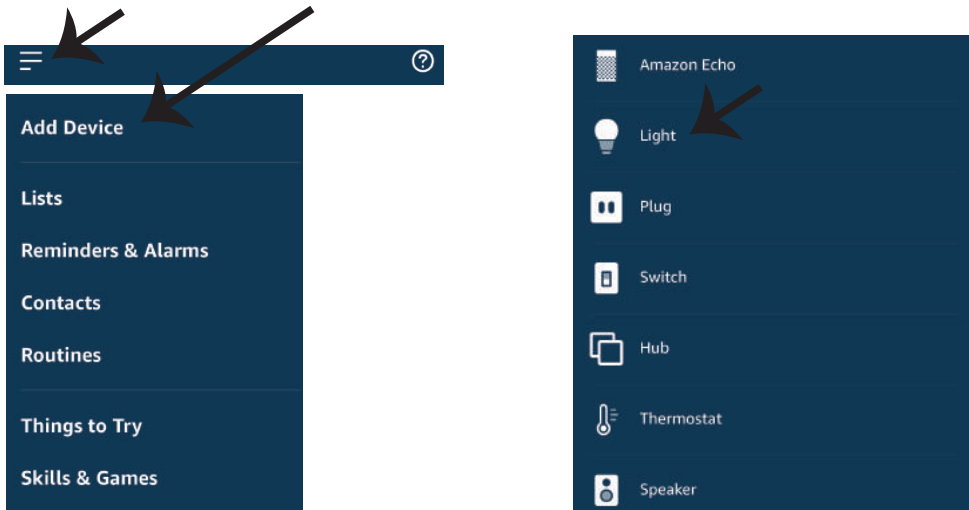

Note: Discovering the device must be done every time the device's name is changed on the app.

ALEXA Commands

Now, you can control your smart device using voice commands on Alexa. Below are a few commands you can use:

- ! *Alexa, turn on/off bedroom light.*
- ! *Alexa, set bedroom light to 50 percent.*
- ! *Alexa, set bedroom light to white.*
- ! *Alexa, set bedroom light to warm white.*

THINGS TO REMEMBER BEFORE STARTING INSTALLATION:

1. V-TAC Smart Light App & Amazon Alexa App
2. Make sure you have Amazon Alexa Device(including Echo, Echo Tap, or Echo Dot)
3. Smart Device
4. Stable Wifi network

GOOGLE HOME SETTINGS

Step1:

- a&b) Install the Google Home app via the App Store (iOS) or the Play Store (Android) and register. If you already have an existing account with Google Home, please proceed to logging in.
- c) Create a New Home/Choose from the existing home if any.
- d) Power ON the Google Home device and connect it to the App.(Then Proceed to step 2)

a. **Welcome home**
Your content and devices all in one place



[GET STARTED >](#)

b. **Choose account**
This account will be used to personalize your experience

c. **Choose a home**
You will be able to control the devices and services in this home.

Create another home

d. **Plug in your device**
Make sure your device is nearby and connected to power, then try again



Step2: Once you are on the Google home page, tap on the Add “+” icon– to add a new device and skill. And then tap on Set up device as shown in below image.

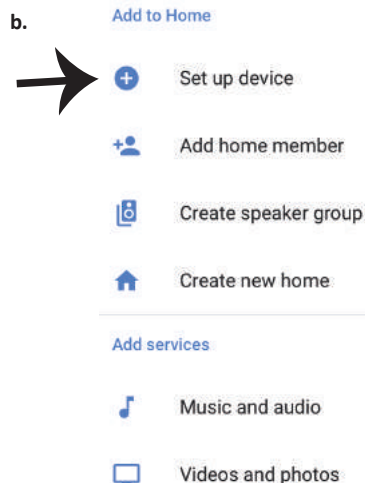
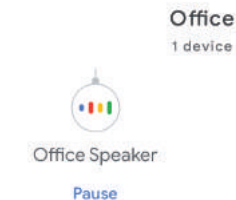
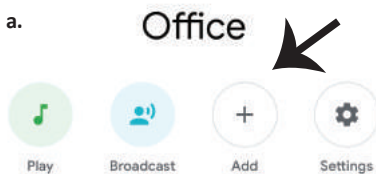

Step3: Make sure the Smart device is paired with V-TAC Smart Light app before starting step 3. Tap on the arrow section as highlighted in the below image.

Step4: Type “V-TAC Smart Light” on the search bar and tap on the icon of “V-TAC Smart Light”

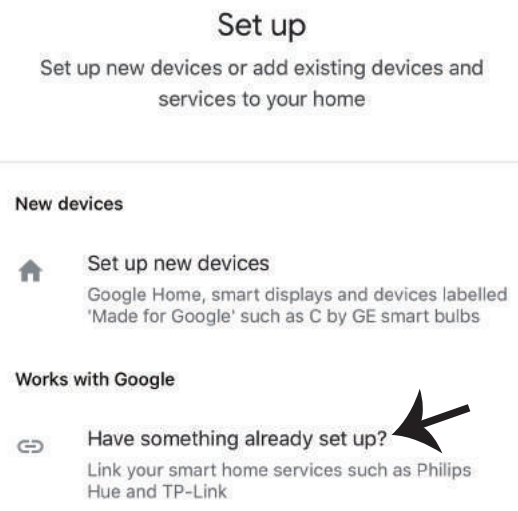

Step5: Sign In with your V-TAC Smart Light Login credentials to Link the Smart Light device

Step6: Tap on Authorize in order to proceed to linking the device.

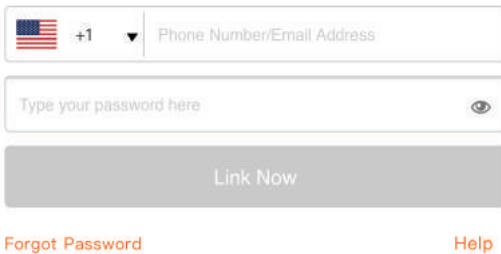

Google will be able to:
Receive your public profile
Control your devices over internet



Step7

a. Account will now be linked, please stay on the page you will be redirected in few seconds to select the device to add to your home.

b. Select the device and tap on Next as show in image b.

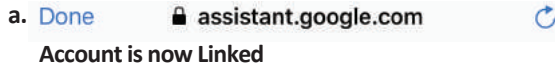

b. Choose device

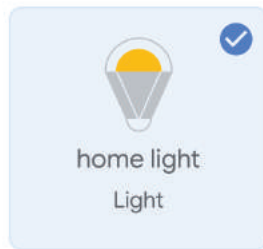

Step8: Select the Home where you would like to add the Smart Light under. (Or) you can create a New home in order to add the Smart Light to it.

Step9: You have successfully added Smart Light device to your Google home App.

Choose a home

You will be able to control the devices and services in this home.

- Smart-Home
- Office
- Smart Home
- Create another home

Smart-Home ▾

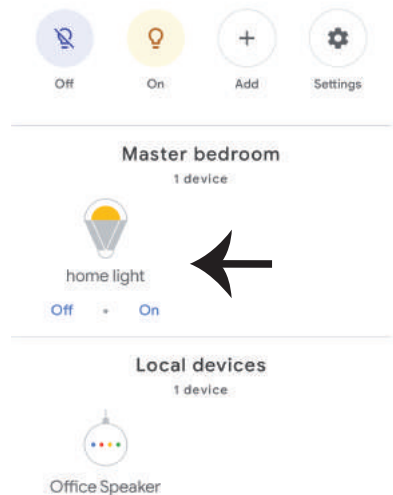

Step10:

a. You can turn the smart device On/OFF by tapping on On/Off options as shown below.

(OR) You can tap on the Smart Light.

b. You will be redirected to page (as shown in image b) where you can control the lights “Power and Dimming functionality”.

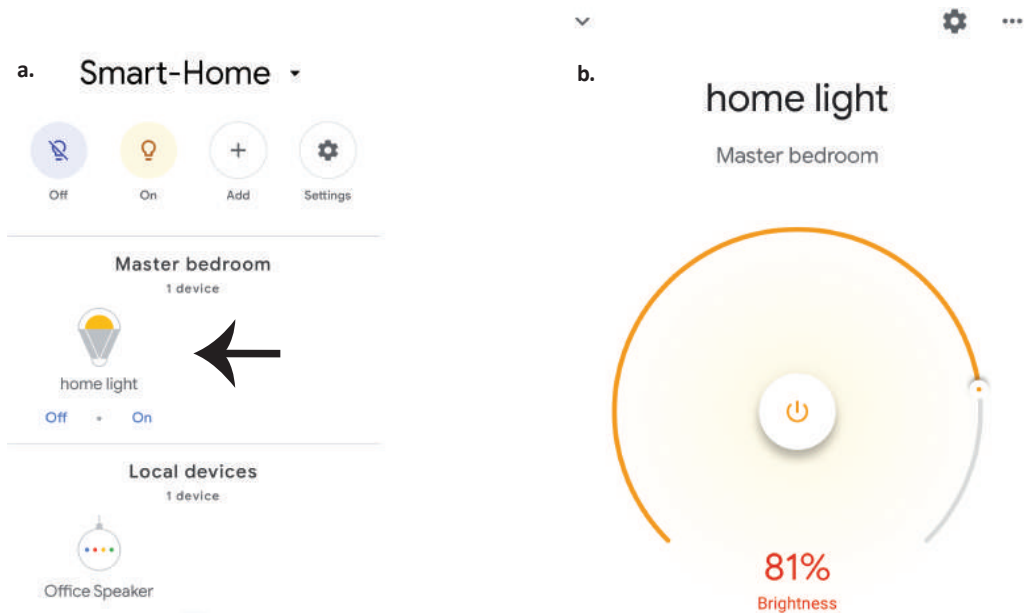
**Google Commands:**

Now, you can control your smart device using voice commands on Google Home. Below are a few example commands:

- ! OK Google, turn on/off bedroom light
- ! OK Google, set bedroom light to 50 percent.
- ! OK Google, set bedroom light to white.
- ! OK Google, set bedroom light to warm white.

THINGS TO REMEMBER BEFORE STARTING INSTALLATION:

1. V-TAC Smart Light App & Google Home App
2. Make sure you have Google Home Device
3. Smart Device
4. Stable Wifi network

INSTRUCTION D'INSTALLATION

- 1) Couper l'électricité avant de commencer l'Installation (voir image Partie 1)
- 2) Tourner et enlever le couvercle (voir image Partie 2)
- 3) Percer un trou dans le plafond pour fixer la lampe à l'aide de vis (Voir image Partie 3)
- 4) Raccorder les fils (Voir image Partie 4) avant de fixer la lampe sur le plafond à l'aide de vis.
- 5) Tourner et verrouiller le couvercle de la lampe (Voir image Partie 5)
- 6) Mettre sous tension et tester la lampe.

AVERTISSEMENT DE SÉCURITÉ

- 1) Les lampes sont limitées à une utilisation à l'intérieur et ne sont pas recommandées pour une utilisation dans un environnement humide.
- 2) Les lampes et les lanternes ne peuvent pas être installées à la surface des matériaux combustibles ordinaires. L'augmentation de la température est normale pour des lampes.
- 3) N'exercez pas de force et ne jetez pas la lampe.
- 4) Les lampes doivent être stockées dans endroit frais/sec. Assurez-vous toujours que l'environnement est propre avant d'installer la lampe.
- 5) Ne jetez pas les lampes avec les déchets ordinaires. Les lampes sont faites avec des composants électroniques et devraient être correctement éliminées aux endroits désignés avec un traitement unifié comme l'équipement électronique traditionnel.

APP INSTALLATION

Étape 1: Scannez le code QR donné, ou téléchargez "V-TAC Smart Light" à partir de l'App Store (iOS) ou du Google Play Store (Android).

For ANDROID



For IOS



Étape 4: Ouvrez l'application V-TAC Smart Light et appuyez «enregistrement»-pour créer un nouveau compte.

V-TAC Smart Light

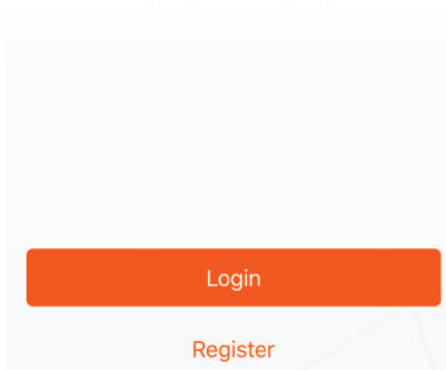

Étape 5:

A) Numéro de téléphone portable: Sélectionnez le pays, puis entrez votre numéro de téléphone portable. Une fois terminé, appuyez «Suivant». B) E-Mail: Entrez votre email et appuyez «Suivant».

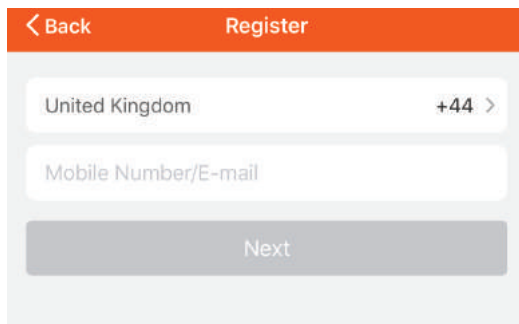

Etape 6: Entrez le code de vérification qui sera envoyé à votre numéro de téléphone portable/e-mail, puis attribuez un nouveau mot de passe à votre compte et appuyez «Suivant».

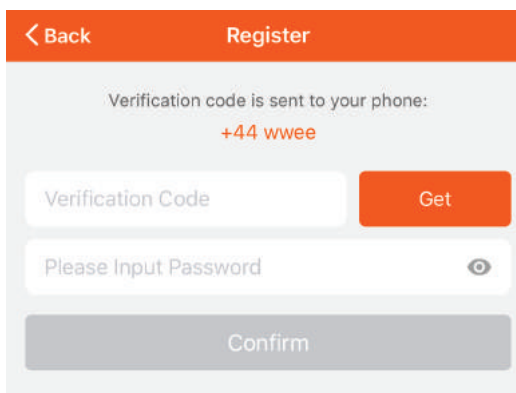

Etape 7: Appuyez sur "Ajouter un appareil" ou sur le signe +. Assurez-vous que la lampe est allumée.

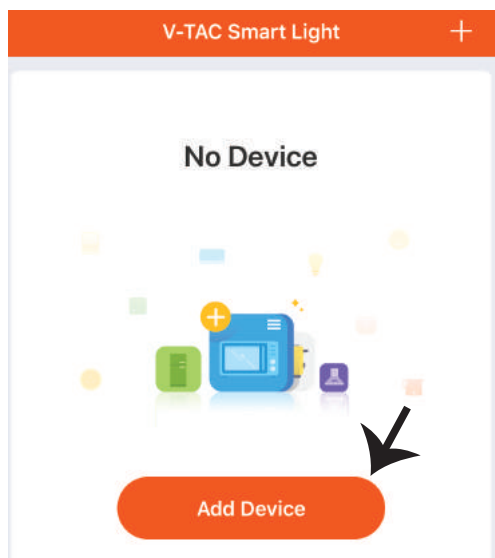

Etape 8: Choisissez "Appareils d'éclairage" pour commencer à appairer la lampe avec l'application.

Etape 9: Pour appairer l'appareil avec la lampe, assurez-vous que la lumière clignote rapidement.

Une fois que la lampe commence à clignoter rapidement, la lampe est en mode d'appairement. Si l'ampoule ne clignote pas rapidement, vous pouvez effectuer l'une des étapes suivantes:

- A. Allumer et éteindre l'ampoule 3 fois, à des intervalles courts de moins de 2 secondes.
- B. Appuyer sur le lien «Comment faire clignoter rapidement la lumière» (comme indiqué sur l'image).

Modes réseau:

- 1) Mode EZ: La lumière clignote deux fois par seconde
- 2) Mode AP: Clignotement lent, une fois toutes les 2 secondes

Sur la page «Ajouter un appareil», confirmez que l'ampoule est en mode EZ. Si ce n'est pas le cas, vous pouvez passer en mode EZ en branchant l'appareil à trois reprises.

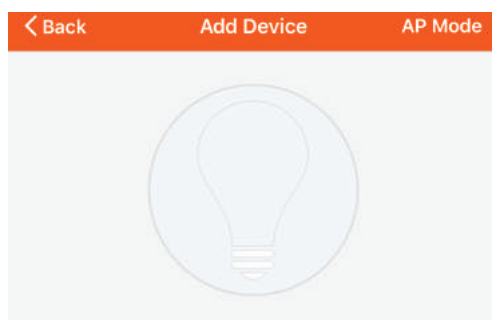
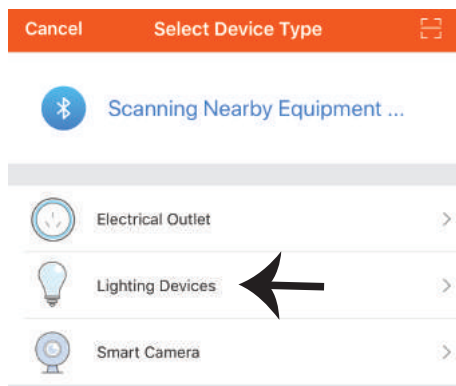

Power on the light and confirm that light blinks rapidly

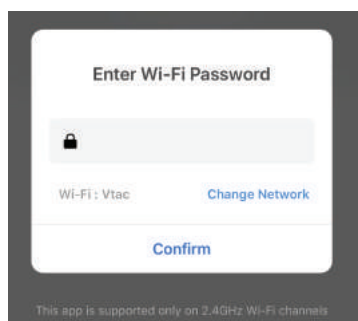

[How to make light blinks rapidly](#)

Confirm light blinks rapidly

Étape 10: Une fois que vous avez complété avec succès l'étape 9, vous serez redirigés vers la page ci-dessous où l'application recherche, enregistre et initialise le dispositif (lampe) (réf. l'image ci-dessous).

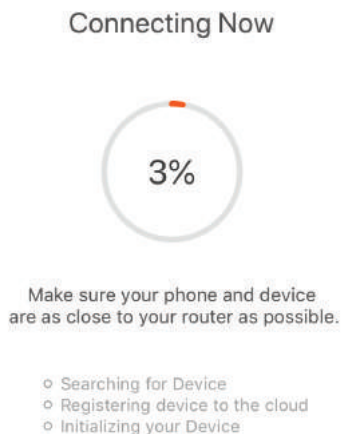

Étape 11: Une fois que votre appareil est ajouté avec succès, renommez l'appareil selon vos préférences.

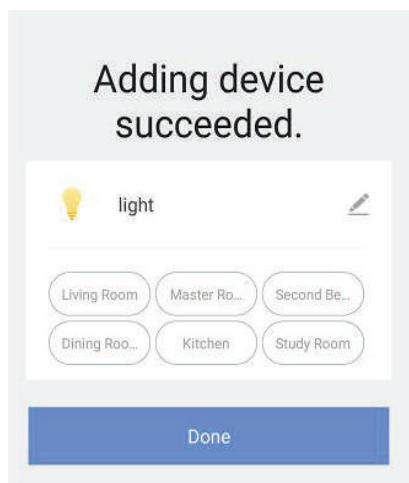

Étape 12: Après avoir appairé avec succès l'ampoule avec l'application, vous pouvez commencer à contrôler plusieurs fonctions de l'ampoule à travers votre portable – interrupteur marche/arrêt, changer la température de couleur, synchronisation et horaires, options d'atténuation, etc.

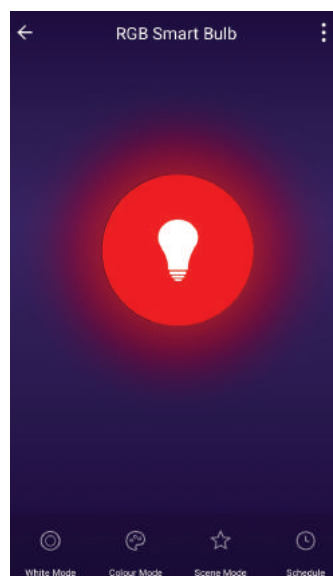
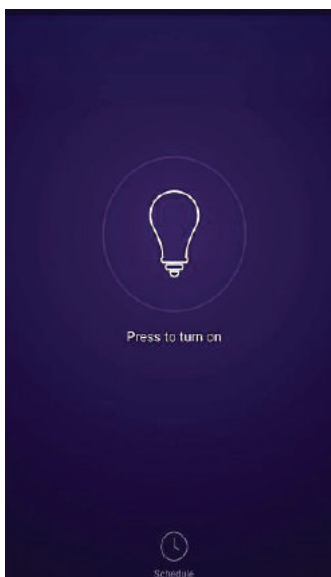
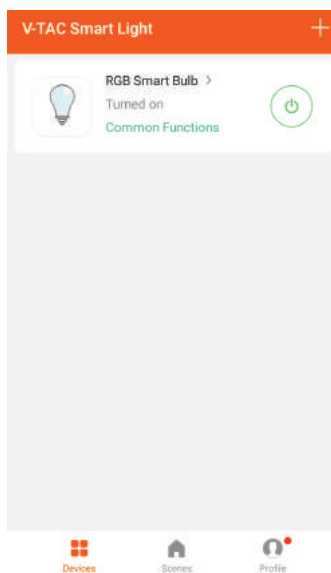

RÉGLAGES ALEXA

Étape 1: Installez l'application Amazon Alexa sur l'App Store (iOS) ou Play Store (Android) et enregistrez-vous. Si vous avez un compte existant sur Amazon Alexa, veuillez vous connecter.

Étape 3: Appuyez sur les réglages  et appuyez sur «Compétences et Jeux» comme indiqué ci-dessous.

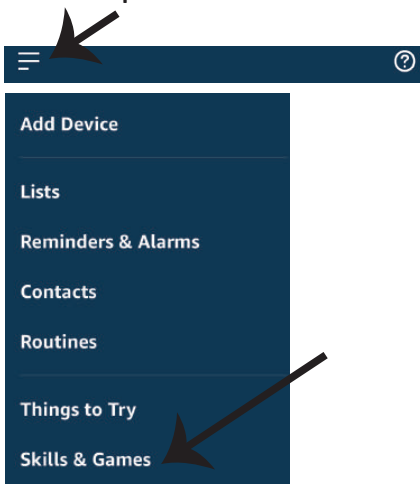

Étape 2: Une fois que vous êtes sur la page d'accueil d'Amazon Alexa, appuyez sur l'icône en bas à droite – où la flèche est pointée – pour ajouter un nouvel appareil et compétence.

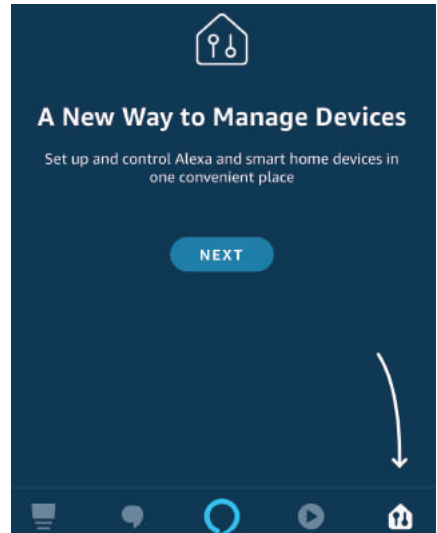

Étape 4: Recherchez pour «V-TAC Smart Light» sur la page «Compétences et jeux» comme indiqué ci-dessous.



Search

Keyword or skill name
V-TAC Smart Light

Étape 5: Activer la compétence.

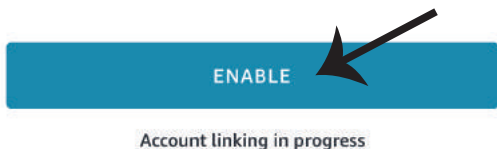

Étape 6: Saisissez le nom d'utilisateur et le mot de passe pour vous connecter sur V-TAC Smart Light et appuyez sur «Appairage maintenant»

 A login form with a white background. At the top left is a dropdown menu showing a US flag and "+1". To its right is a text input field with the placeholder "Phone Number/Email Address". Below this is another text input field with the placeholder "Type your password here" and an eye icon on the right. A grey "Link Now" button is centered below the password field. At the bottom, there are two links: "Forgot Password" on the left and "Help" on the right.

Étape 7: Une fois que vous avez appuyé sur «Appairage maintenant», vous serez redirigé vers une nouvelle page qui demande une autorisation (réf. l'image ci-dessous) Appuyez «Autoriser».



Alexa by Amazon will be able to:

- Receive your public profile
- Control your devices over internet

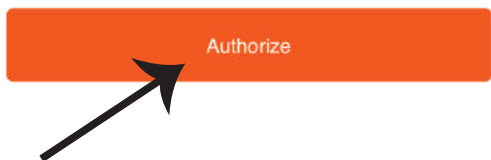

Étape 8: Vous recevrez une confirmation du compte appairé avec succès (réf. l'image ci-dessous)

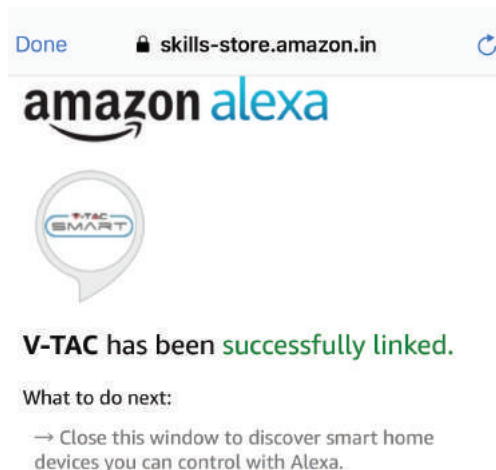

Étape 9: Découvrez votre appareil intelligent sur Alexa. Ensuite autorisez la compétence

A) Vous pouvez utiliser la commande vocale «Alexa, détecte les appareils» au dispositif Alexa dont vous disposez.

B) Pour ajouter un dispositif manuellement, appuyez  sur la page d'accueil et ensuite Ajouter un dispositif, sélectionner le dispositif que vous souhaitez ajouter et appuyez Détecter le dispositif.

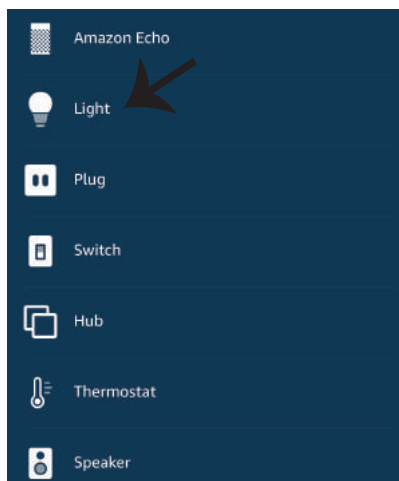
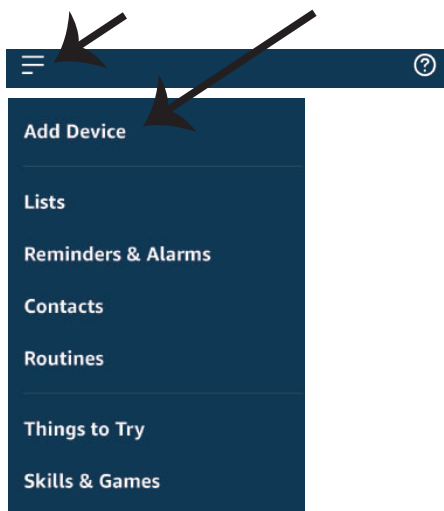

Nota: La détection d'un appareil doit être effectuée chaque fois quand le nom de l'appareil est modifié sur l'application.

Commandes ALEXA

Maintenant, vous pouvez contrôler votre appareil intelligent à l'aide de commandes vocales sur Alexa. Voici quelques commandes que vous pouvez utiliser:

- ! *Alexa, turn on/off bedroom light.*
- ! *Alexa, set bedroom light to 50 percent.*
- ! *Alexa, set bedroom light to green.*
- ! *Alexa, set bedroom light to warm white.*

CHOSSES À RAPPELER AVANT DE COMMENCER L'INSTALLATION:

1. Application V-TAC Smart Light & Application Amazon Alexa
2. Assurez-vous que vous avez le dispositif Amazon Alexa (y compris Echo, Echo Tap, ou Echo Dot)
3. Appareil intelligent – Lampe
4. Réseau sans fil stable

RÉGLAGES GOOGLE HOME

Étape 1:

a&b) : Installez l'application Google Home sur l'App Store (iOS) ou Play Store (Android) et enregistrez-vous. Si vous avez un compte existant sur Google Home, veuillez vous connecter.

c) Créez une Nouvelle maison/sélection de la maison existante, le cas échéant.

d) Branchez le dispositif Google Home et appariez-le à l'application. (Ensuite procéder à l'étape 2)

a. Welcome home

Your content and devices all in one place



GET STARTED >

b. Choose account

This account will be used to personalize your experience

c. Choose a home

You will be able to control the devices and services in this home.



Create another home

d. Plug in your device

Make sure your device is nearby and connected to power, then try again

Étape 2: Une fois que vous êtes sur la page Google Home, appuyez sur l'icône Ajouter«+»– pour ajouter un nouvel appareil et compétence. Ensuite, appuyez sur Réglage de l'appareil comme indiqué sur l'image ci-dessous.

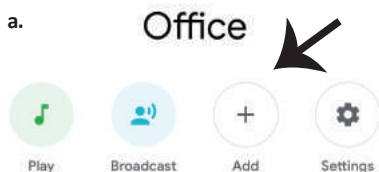

Office
1 device



Office Speaker

Pause

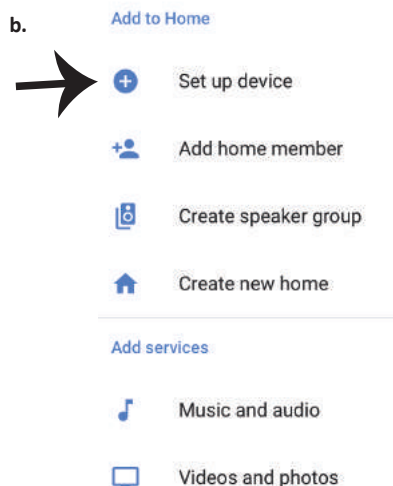

Étape 3: Assurez-vous que l'ampoule intelligente est appairée à l'application V-TAC Smart Light avant de commencer l'étape 3. Tapez sur la section de la flèche, comme souligné sur l'image ci-dessous.



Set up

Set up new devices or add existing devices and services to your home



New devices

 **Set up new devices**
Google Home, smart displays and devices labelled 'Made for Google' such as C by GE smart bulbs

Works with Google

 **Have something already set up?** 
Link your smart home services such as Philips Hue and TP-Link

Étape 5: Connectez-vous avec vos identifiants «V-TAC Smart Light» pour lier l'appareil «Éclairage intelligent»

 +1  Phone Number/Email Address

Type your password here 

Link Now

[Forgot Password](#)

[Help](#)

Étape 4: Tapez « V-TAC Smart Light » sur la barre de recherche et appuyez sur l'icône « V-TAC Smart Light»



V-TAC Smart Life 

Étape 6: Sélectionnez V-TAC Smart Light comme indiqué ci-dessous et appuyez sur «Lier maintenant».



Google will be able to:

Receive your public profile
Control your devices over internet

Authorize 

Étape 7:

- a. Votre compte sera désormais relié, veuillez rester sur la page et vous allez être redirigé dans quelques secondes pour sélectionner l'appareil à ajouter à votre maison.
- b. Sélectionnez l'appareil, appuyez sur Suivant (comme indiqué sur l'image b).



b. Choose device

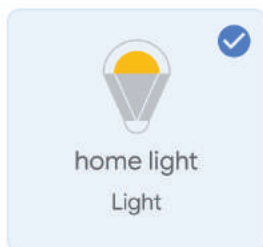

Étape 8: Choisissez la «Maison» où vous souhaitez ajouter l'éclairage intelligent. (ou) vous pouvez créer une «Nouvelle maison» afin d'y ajouter l'éclairage intelligent.

Choose a home

You will be able to control the devices and services in this home.

- Smart-Home
- Office
- Smart Home
- Create another home

Étape 9: Vous avez ajouté avec succès l'appareil «Éclairage intelligent» à votre application «Google Home».

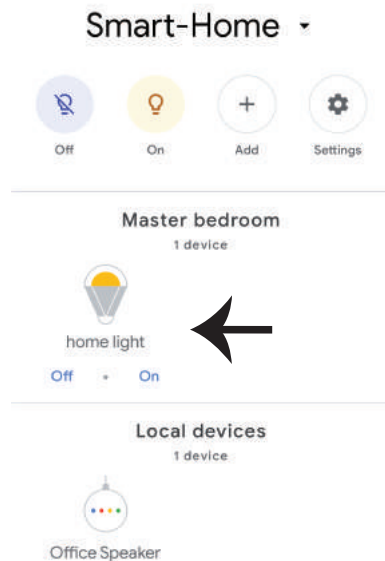

Étape 10:

- a. Vous pouvez allumer/éteindre la lampe en sélectionnant les options Marche/Arrêt (comme indiqué sur l'image a). (OU) Vous pouvez appuyer sur la lampe intelligente.
- b. Vous serez redirigés vers la page (comme indiqué sur l'image b) où vous pouvez contrôler les lumières «Fonctionnalité de puissance et d'atténuation».

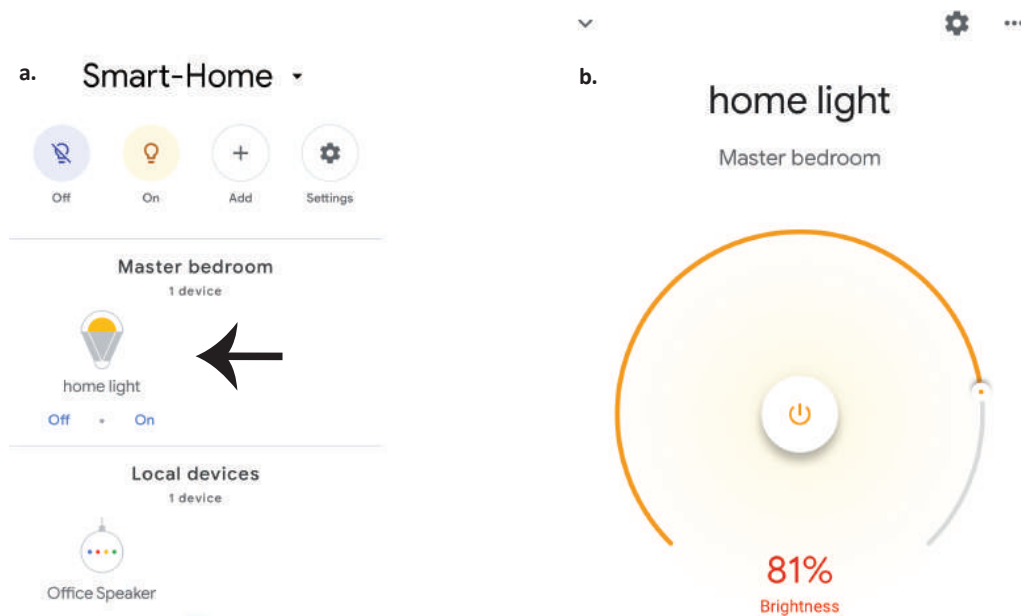
**Commandes Google:**

Maintenant, vous pouvez contrôler votre appareil intelligent à l'aide de commandes vocales sur Google Home. Voici quelques commandes que vous pouvez utiliser

- ! *OK Google, turn on/off bedroom light*
- ! *OK Google, set bedroom light to 50 percent.*
- ! *OK Google, set bedroom light to green.*
- ! *OK Google, set bedroom light to warm white.*

CHOSSES À RAPPELER AVANT DE COMMENCER L'INSTALLATION:

1. Application V-TAC Smart Light & Application Google Home
2. Assurez-vous que vous avez le dispositif Google Home
3. Appareil intelligent – Lampe
4. Réseau sans fil stable

INSTALLATIONSANFORDERUNGEN/ ANLEITUNG

- 1) Schalten Sie die Stromversorgung aus, bevor Sie mit der Montage beginnen (Hinweis Bild Teil 1)
- 2) Twist hen und entfernen Sie die Abdeckung (Hinweis Bild Teil 2)
- 3) Bohren Sie ein Loch in die Decke, um die Leuchte mit Schrauben zu befestigen (Hinweis Bild Teil3)
- 4) Schließen Sie die Kabel an (Hinweis Bild Teil 4), bevor Sie die Leuchte mit Schrauben an der Decke befestigen.
- 5) Drehen und verriegeln Sie die Abdeckung zu der Leuchte (Hinweis Bild Teil 5)
- 6) Schalten Sie die Stromversorgung ein und testen Sie die Leuchte.

SICHERHEITS WARNUNG

- 1) Lampen sind auf den Gebrauch in Innenräumen beschränkt und für den Einsatz in feuchter Umgebung nicht zu empfehlen
- 2) Lampen und Laternen können nicht auf der Oberfläche gewöhnlicher brennbarer Materialien installiert werden. Temperaturerhöhung ist für Lampen normal.
- 3) Wenden Sie keine äußere Kraft an und werfen Sie die Lampe nicht.
- 4) Die Lampen sollten an einem kühlen / trockenen Ort aufbewahrt werden. Stellen Sie immer sicher, dass die Umgebung sauber ist, bevor Sie die Lampe installieren.
- 5) Werfen Sie die Lampen nicht in den Hausmüll. Lampen werden aus elektronischen Komponenten hergestellt und sollten an bestimmten Stellen mit einheitlicher Behandlung wie herkömmliche elektronische Geräte ordnungsgemäß entsorgt werden.

APP INSTALLATION

Schritt 1: Scannen Sie den angegebenen QR-Code oder laden Sie „V-TAC Smart Light“ aus dem App Store (iOS) oder dem Google Play Store (Android) herunter.

For ANDROID



For IOS



Schritt 4: Öffnen Sie die V-TAC Smart Light App. Tippen Sie auf Registrieren, um ein neues Konto zu erstellen

V-TAC Smart Light

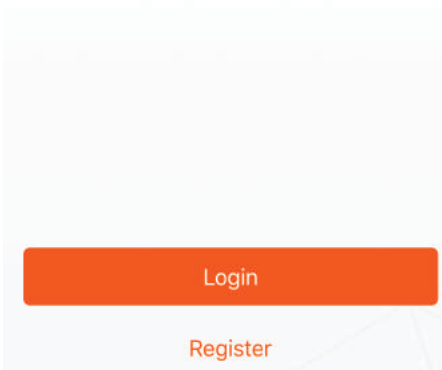

Schritt 5:

A) Handynummer: Wählen Sie das Land aus und geben Sie Ihre Handynummer ein. Wenn Sie fertig sind, tippen Sie auf "Weiter".

B) E-Mail: Geben Sie Ihre E-Mail-ID ein und tippen Sie auf "Weiter".

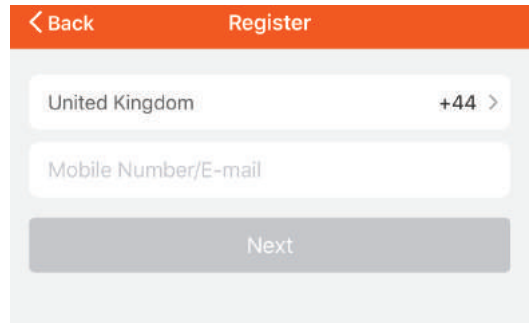

Schritt 6: Geben Sie den Bestätigungscode ein, der an Ihre Handynummer / E-Mail-ID gesendet wird, weisen Sie Ihrem Konto ein neues Passwort zu und tippen Sie auf "Bestätigen".

Schritt 7: Tippen Sie auf "Gerät hinzufügen" oder das Pluszeichen. Stellen Sie sicher, dass die Lampe eingeschaltet ist.

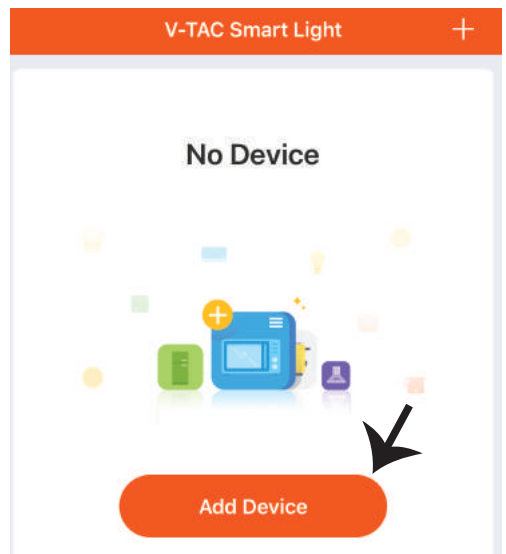
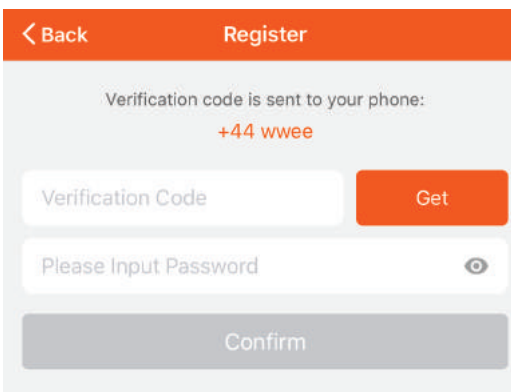

Schritt 8: Wählen Sie „Beleuchtungsgeräte“, um die Lampe mit der App zu koppeln.

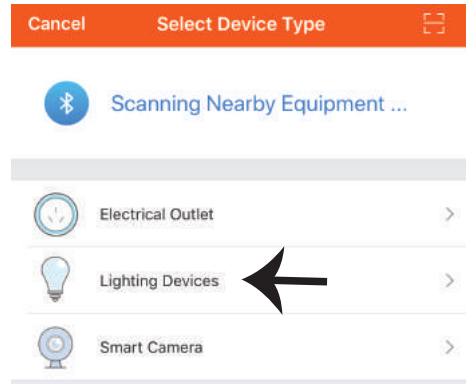

Schritt 9: Um das Gerät mit der Lampe zu koppeln, stellen Sie sicher, dass das Licht schnell blinkt.

Sobald das Licht schnell blinkt, befindet sich die Lampe im Pairing-Modus. Wenn die Lampe nicht schnell blinkt, können Sie einen der folgenden Schritte ausführen:

- A. Schalten Sie die Glühbirne dreimal wiederholt in kurzen Intervallen von weniger als 2 Sekunden ein und aus.
- B. Tippen Sie auf den Link "So machen Sie das Licht schnell blinken" (wie auf dem Bild gezeigt).

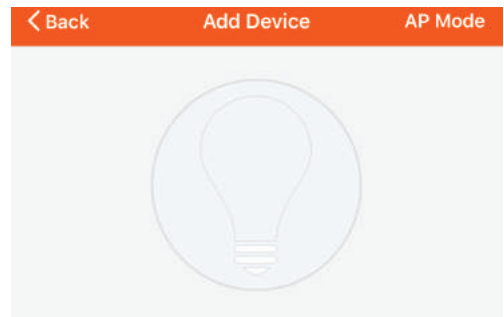

Power on the light and confirm that light blinks rapidly

Netzwerkmodi:

- 1) EZ-Modus: Das Licht blinkt zweimal pro Sekunde
 - 2) AP-Modus: Langsames Blinken einmal alle 2 Sekunden
- Überprüfen Sie auf der Seite "Gerät hinzufügen", ob sich die Glühbirne im EZ-Modus befindet. Wenn nicht, können Sie durch dreimaliges Einschalten des Geräts in den EZ-Modus wechseln.

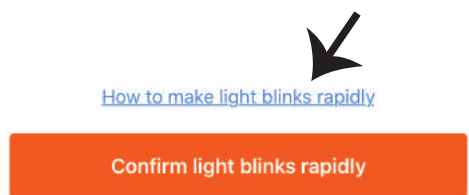
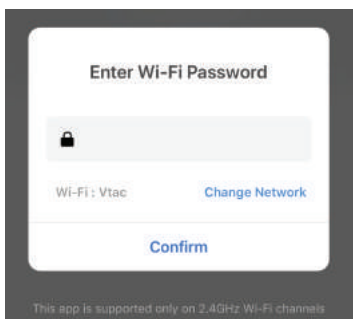

Schritt 10: Nachdem Sie Schritt 9 erfolgreich abgeschlossen haben, werden Sie zur unteren Seite weitergeleitet, auf der die App das Gerät (Lampe) sucht, registriert und initialisiert (siehe Abbildung unten).

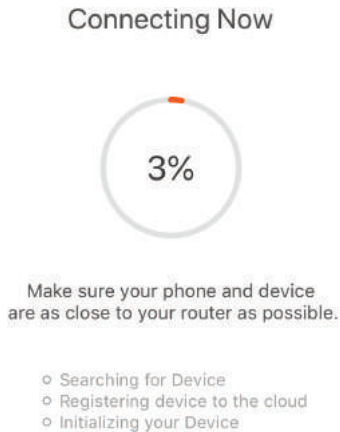

Schritt 11: Sobald Ihr Gerät erfolgreich hinzugefügt wurde, benennen Sie das Gerät wie Sie wünschen um.

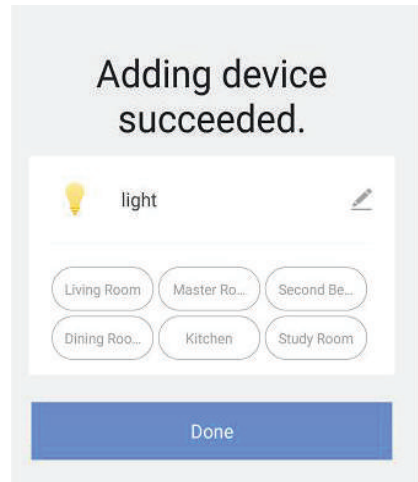

Schritt 12: Nachdem Sie die Lampe erfolgreich mit der App gekoppelt haben, können Sie mit Ihrem Mobiltelefon mehrere Funktionen der Lampe steuern (Ein / Aus-Schalter), Farbtemperatur, Timing & Zeitpläne, Dimmoptionen und mehr ändern.

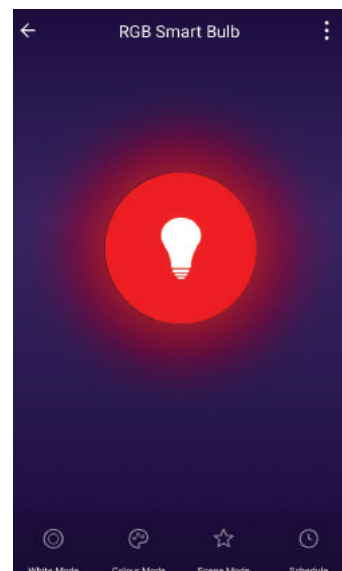
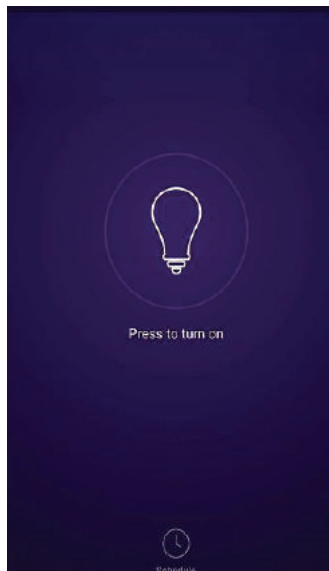
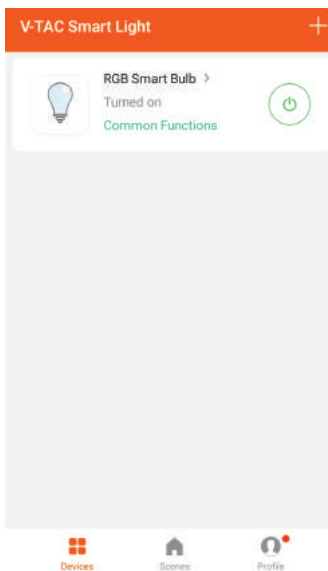

ALEXA SETTINGS

Schritt 1: Installieren Sie die Amazon Alexa-App über den App Store (iOS) oder den Play Store (Android) und registrieren Sie sich. Wenn Sie bereits ein Konto bei Amazon Alexa haben, melden Sie sich bitte an.

Schritt 3: Tippen Sie auf  Einstellungen und tippen Sie auf "Fähigkeiten und Spiele" (siehe unten).

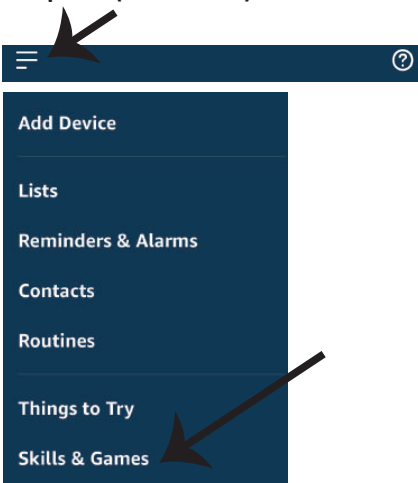

Schritt 2: Sobald Sie sich auf der Amazon Alexa-Startseite befinden, tippen Sie auf das untere rechte Symbol, wo der Pfeil angezeigt wird, um ein neues Gerät und eine neue Fähigkeit hinzuzufügen.

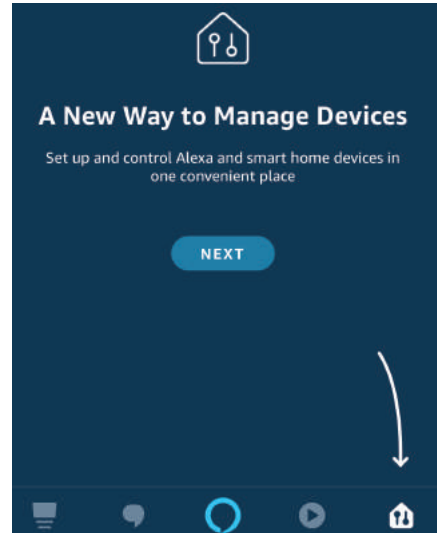

Schritt 4: Suchen Sie auf der Seite „Skills & Games“ nach „V-TAC Smart Light“ (siehe unten).

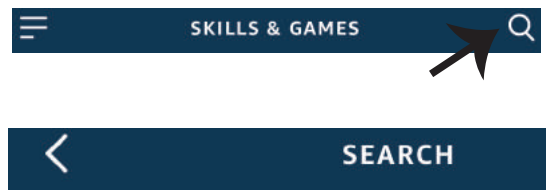

Search

Keyword or skill name
V-TAC Smart Light

Schritt 5: Aktivieren Sie die Fähigkeit.

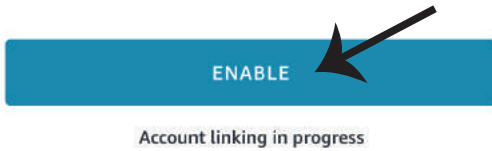

Schritt 6: Geben Sie Ihre V-TAC Smart Light-Login-ID und Ihr Kennwort ein und tippen Sie auf „Link Now“.

Schritt 7: Wenn Sie auf Jetzt verknüpfen klicken, werden Sie auf eine neue Seite umgeleitet, die Sie zur Autorisierung auffordert (Bild unten). Tippen Sie auf "Authorize".



Alexa by Amazon will be able to:

- Receive your public profile
- Control your devices over internet



Schritt 8: Sie erhalten eine Bestätigung, daß das Konto erfolgreich verknüpft wurde (siehe Bild unten).

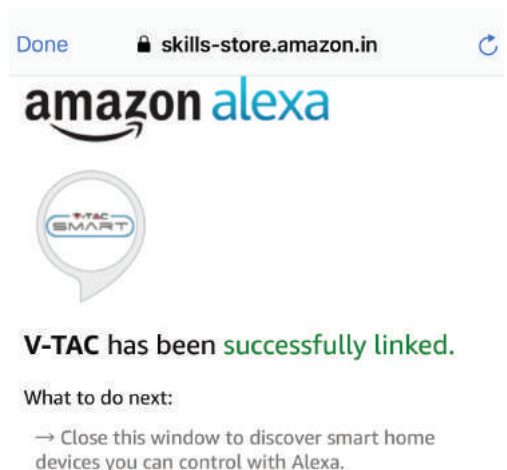

Schritt 9: Entdecken Sie Ihr Smartphone auf Alexa. Sobald Sie die Fertigkeit aktiviert haben, A) können Sie den Sprachbefehl „Alexa Discover Devices“ für das Alexa-Gerät verwenden, über das Sie verfügen.

B) Um das Gerät manuell auf der Startseite hinzuzufügen, tippen Sie auf  und dann auf „Add Device“. Wählen Sie das Gerät aus, das Sie hinzufügen, und tippen Sie auf „Discover Device“.

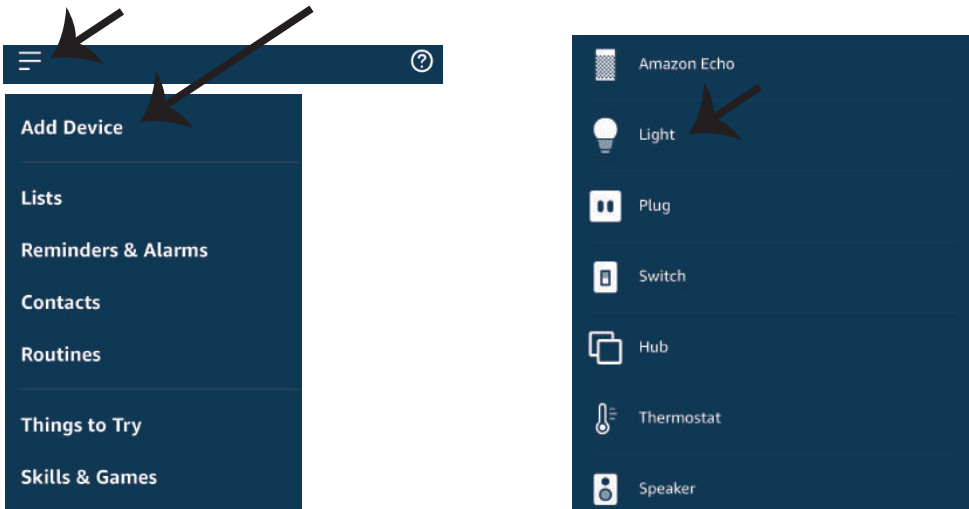

Hinweis: Die Erkennung des Geräts muss jedes Mal durchgeführt werden, wenn der Name des Geräts in der App geändert wird.

ALEXA Befehle

Jetzt können Sie Ihr intelligentes Gerät mit Sprachbefehlen für Alexa steuern. Nachfolgend einige Befehle, die Sie verwenden können:

- ! *Alexa, turn on/off bedroom light.*
- ! *Alexa, set bedroom light to 50 percent.*
- ! *Alexa, set bedroom light to green.*
- ! *Alexa, set bedroom light to warm white.*

EMPFEHLUNGEN VOR DEM START DER INSTALLATION:

1. *V-TAC Smart Light App & Amazon Alexa App*
2. *Stellen Sie sicher, dass Sie über ein Amazon Alexa-Gerät verfügen (einschließlich Echo, Echo Tap oder Echo Dot).*
3. *Intelligentes Gerät - Lampe*
4. *Stabiles WLAN-Netzwerk*

GOOGLE HOME EINSTELLUNGEN

Schritt 1:

a & b) Installieren Sie die Google Home App über den App Store (iOS) oder den Play Store (Android) und registrieren Sie sich. Wenn Sie bereits ein Konto bei Google Home haben, melden Sie sich bitte an.

c) Erstellen Sie ein neues Zuhause / Wählen Sie ggf. ein vorhandenes Zuhause aus.

d) Schalten Sie das Google Home-Gerät ein und verbinden Sie es mit der App. (Dann weiter mit Schritt 2)

a. Welcome home

Your content and devices all in one place



[GET STARTED >](#)

b. Choose account

This account will be used to personalize your experience

c. Choose a home

You will be able to control the devices and services in this home.



Create another home

d. Plug in your device

Make sure your device is nearby and connected to power, then try again

Schritt 2: Sobald Sie sich auf der Google Home-Startseite befinden, tippen Sie auf das Plusymbol, um ein neues Gerät und eine neue Fähigkeit hinzuzufügen. Tippen Sie anschließend auf Gerät einrichten wie unten auf dem Bild gezeigt.

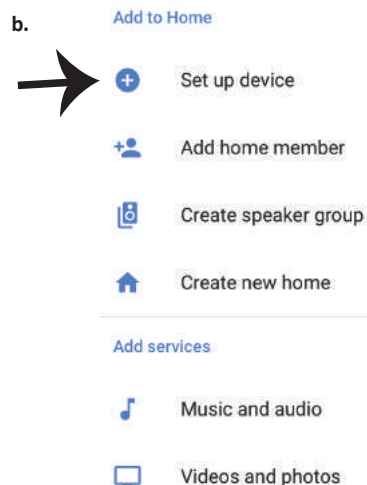
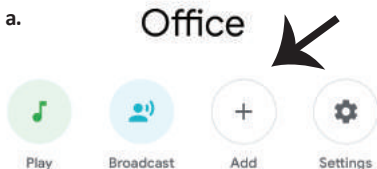

Office
1 device



Office Speaker

Pause

Schritt 3: Stellen Sie sicher, dass die intelligente Glühbirne mit der V-TAC Smart Light-App gekoppelt ist, bevor Sie mit Schritt 3 beginnen. Tippen Sie auf den Pfeilbereich, wie auf dem Bild unten hervorgehoben ist.

Set up

Set up new devices or add existing devices and services to your home

New devices



Set up new devices

Google Home, smart displays and devices labelled 'Made for Google' such as C by GE smart bulbs

Works with Google



Have something already set up?

Link your smart home services such as Philips Hue and TP-Link

Schritt 5: Melden Sie sich mit Ihren V-TAC Smart Light-Kontodaten an, um das intelligente Leben-Gerät zu verknüpfen.

🇺🇸 +1 ▼

👁️

Link Now

[Forgot Password](#)

[Help](#)

Schritt 4: Geben Sie "V-TAC Smart Light" in die Suchleiste ein und tippen Sie auf das Symbol "V-TAC Smart Light"



V-TAC Smart Life



Schritt 6: Wählen Sie V-TAC Smart Light wie unten gezeigt und tippen Sie auf Jetzt verknüpfen.



Google will be able to:

Receive your public profile
Control your devices over internet

Authorize



Schritt 7:

- a. Ihr Konto wird jetzt verlinkt. Bitte bleiben Sie auf der Seite, Sie werden in wenigen Sekunden weitergeleitet, um das Gerät auszuwählen, das Sie zu Hause hinzufügen möchten.
- b. Wählen Sie das Gerät aus und tippen Sie auf Weiter (wie auf dem Bild b gezeigt).



b. ✕ Choose device

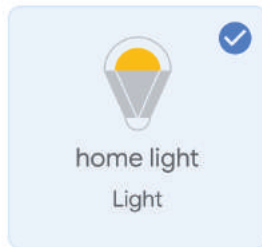

Schritt 8: Wählen Sie das Zuhause aus, wo Sie das Intelligente Light hinzufügen möchten. (Oder) Sie können ein Neues Zuhause erstellen, um ein Intelligentes Light zu dem hinzuzufügen.

Choose a home

You will be able to control the devices and services in this home.

- Smart-Home
- Office
- Smart Home
- Create another home

Schritt 9: Sie haben erfolgreich das Intelligente Light zu Ihrer Google-Home-App hinzugefügt.

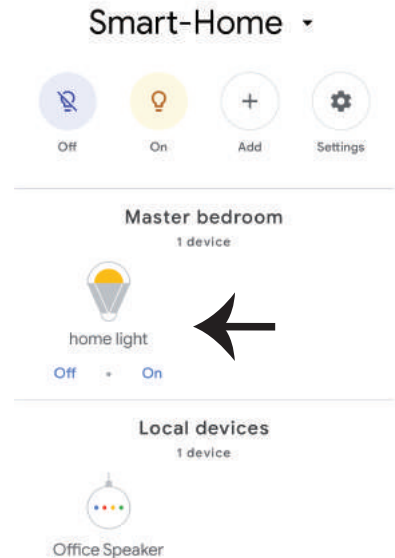

Schritt 10:

- a. Sie können die Lampe ein- und ausschalten, indem Sie auf Ein / Aus-Optionen tippen (wie auf Bild a gezeigt). (ODER) Sie können auf die intelligente Lampe tippen.
- b. Sie werden zu der Seite weitergeleitet (wie auf Bild b gezeigt), auf der Sie die Beleuchtung "Ein / Aus- und Dimmfunktion" steuern können.

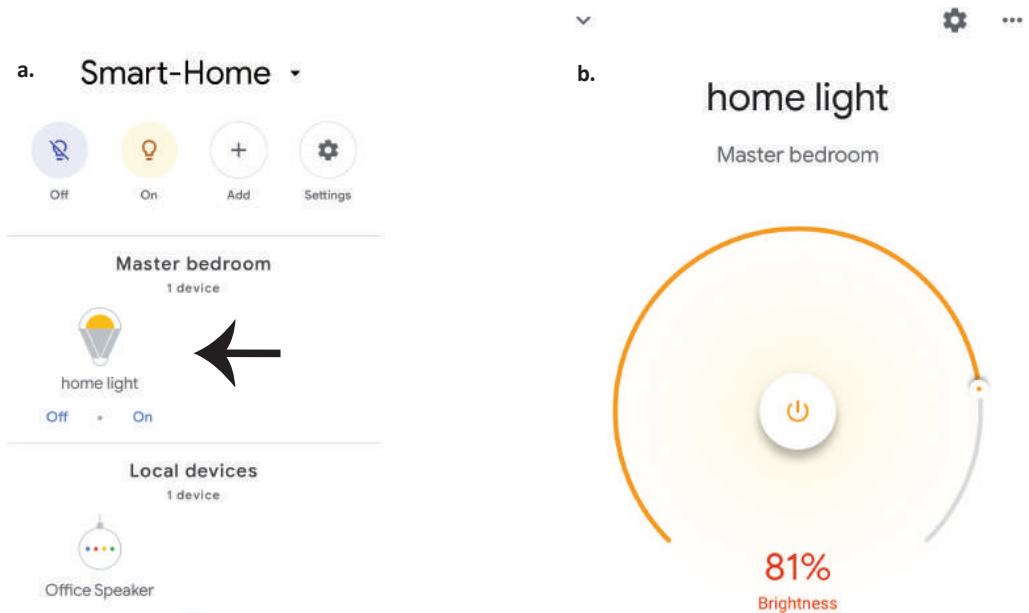
**GOOGLE HOME-Befehle**

Jetzt können Sie Ihr intelligentes Gerät mit Sprachbefehlen für Google Home steuern.
Nachfolgend einige Befehle, die Sie verwenden können:

- ! *OK Google, turn on/off bedroom light*
- ! *OK Google, set bedroom light to 50 percent.*
- ! *OK Google, set bedroom light to green.*
- ! *OK Google, set bedroom light to warm white.*

EMPFEHLUNGEN VOR DEM START DER INSTALLATION:

1. *V-TAC Smart Light App & Google Home App*
2. *Stellen Sie sicher, dass Sie über ein Google Home-Gerät verfügen*
3. *Intelligentes Gerät - Lampe*
4. *Stabiles WLAN-Netzwerk*

ИНСТРУКЦИИ ЗА ИНСТАЛАЦИЯ

- 1) Преди да започнете монтажа, изключете електрозахранването (вж. фигурата Част 1).
- 2) ъртете и свалете капака (вж. фигурата Част 2).
- 3) Пробийте отвор в тавана, за да фиксирате лампата с помощта на винтове (вж. фигурата Част 3).
- 4) Свържете проводниците (вж. фигурата Част 4), преди да фиксирате лампата на тавана с винтовете.
- 5) Завъртете и блокирайте капака към лампата (вж. фигурата Част 5)
- 6) Включете електрозахранването и тествайте лампата.

ПРЕДУПРЕЖДЕНИЕ ЗА БЕЗОПАСНОСТ

- 1) Лампите са ограничени до вътрешно ползване и не е препоръчително да се използват във влажна среда
- 2) Лампите и фенерите не могат да бъдат инсталирани върху повърхността на обикновените запалителни материали. Повишаване на температурата е обичайна за лампите.
- 3) Не упражнявайте външна сила или не хвърляйте лампата.
- 4) Лампите трябва да бъдат съхранявани на хладно/сухо място. Винаги се уверявайте, че околната среда е чиста преди инсталацията на лампата.
- 5) Не изхвърляйте лампите с обичайните отпадъци. Лампите са изградени от електронни компоненти и трябва да бъдат надлежно депонирани на обозначени места с обединено третиране като традиционно електронно оборудване.

APP ИНСТАЛАЦИЯ

Стъпка 1: Сканирайте посочения QR код или изтеглете “V-TAC Smart Light” от App Store (iOS) или “Google Play Store” (Андроид).

For ANDROID



For IOS



Стъпка 4: Отворете приложението на Ви-Тек (V-TAC) Smart Light и натиснете Register (регистрация), за да създадете нов акаунт.

V-TAC Smart Light

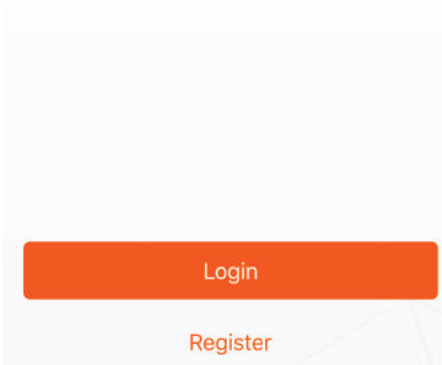

Стъпка 5:

А) Мобилен номер: Изберете страната и въведете номер на мобилен телефон. След това натиснете 'Next'.

В) Електронна поща: Въведете адрес на електронна поща и натиснете 'Next'.

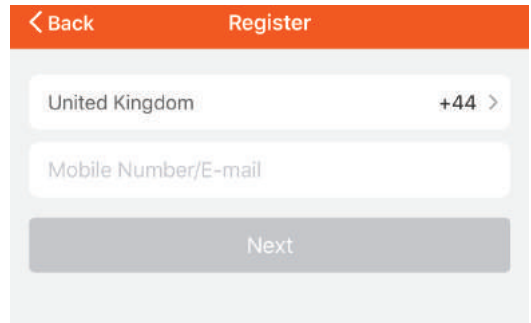

Стъпка 6: Въведете верификационния код, който ще бъде изпратен на мобилния телефон / електронната поща, след което присвоете нова парола на Вашия акаунт и натиснете "Confirm".

Стъпка 7: Натиснете "Добавяне на устройство" или символ +. Уверете се, че лампата е включена

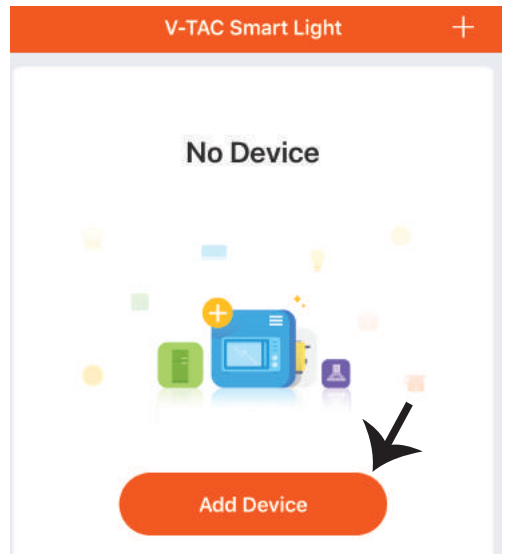
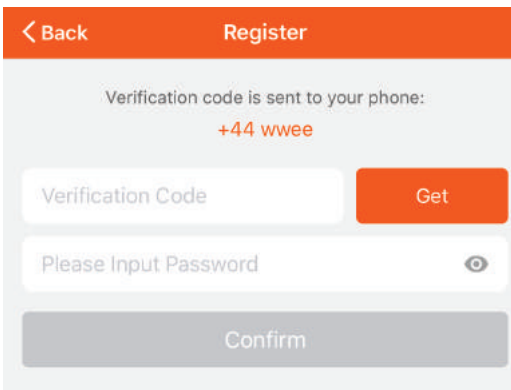

Стъпка 8: Изберете “Устройства за осветление”, за да започнете да свързвате лампата с приложението.

Стъпка 9: За да свържете устройството с лампата се уверете, че светлината мига бързо.

След като лампата започне да мига бързо, тя е в режим на свързване. Ако крушката не мига бързо, можете да предприемете една от следните стъпки:

А. Включете и изключете крушката 3 пъти на кратки интервали по-малки от 2 секунди.

В. Натиснете връзката “Как да накараме осветлението да мига бързо” (както е показано на изображението)

Режими на мрежата:

1) EZ режим: Светлината примигва два пъти в секунда

2) AP режим: Бавно примигване, веднъж на всеки 2 секунди

На страница “Добавяне на устройство”, потвърдете дали крушката е в режим EZ. Ако не е, можете да превключите в режим EZ като включите устройството три пъти.

Потвърдете дали светлината мига бързо, изберете WiFi мрежата и въведете паролата.

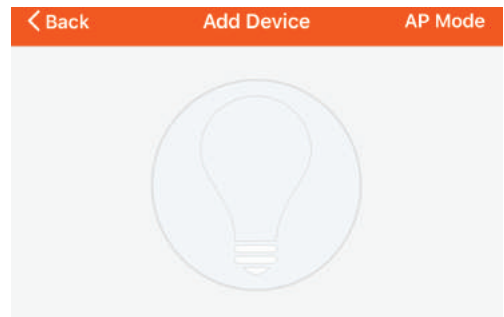
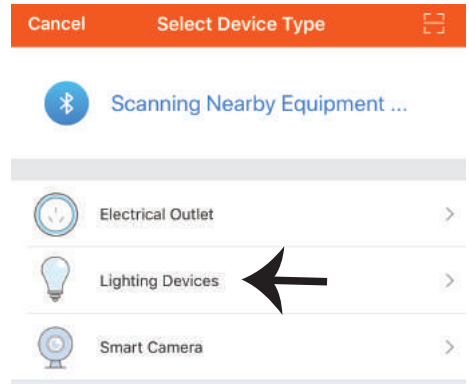
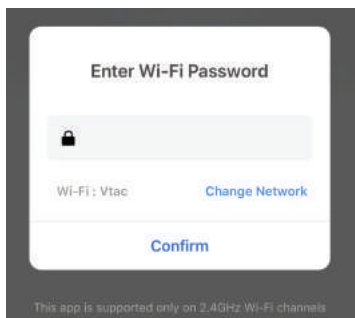

Power on the light and confirm that light blinks rapidly

[How to make light blinks rapidly](#)

Confirm light blinks rapidly

Стъпка 10: След като завършите успешно стъпка 9, ще бъдете пренасочени към долната страница, където приложението търси, регистрира и инициализира устройството (лампата) (вж. фигурата по-долу).

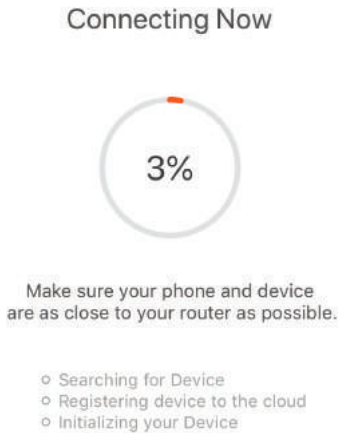

Стъпка 11: След като вашето устройство е успешно добавено, преименувайте устройството както предпочитате.

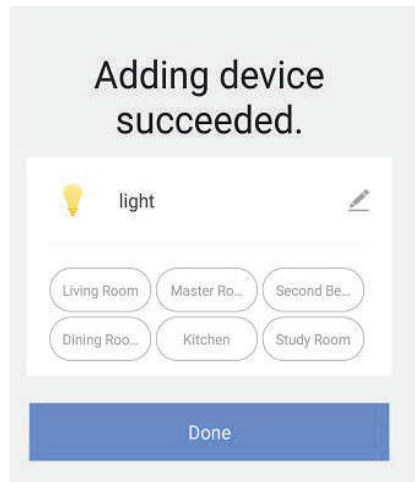

Стъпка 12: След като успешно свържете лампата с приложението, вече можете да управлявате редица характеристики на лампата през мобилния телефон – включване/ изключване, промяна на цветната температура, синхронизация и графици, опции за димиране и много повече.

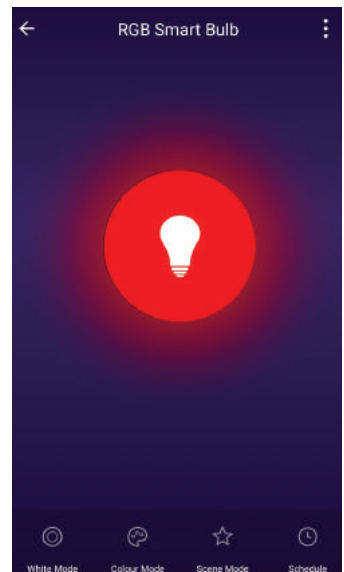
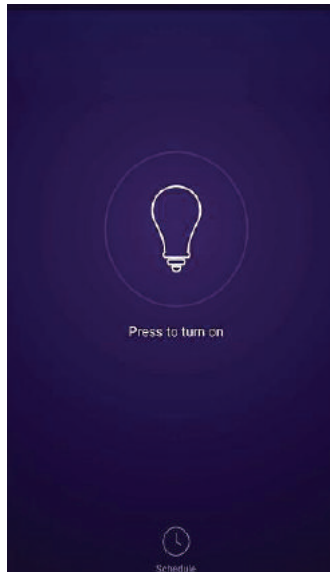
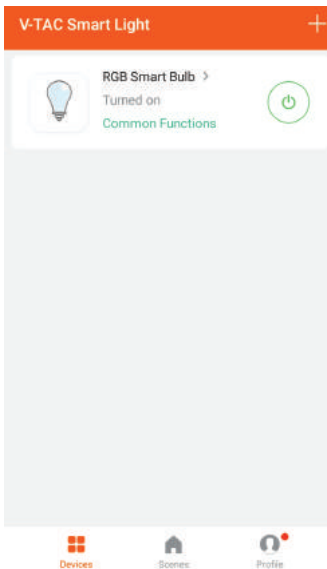

НАСТРОЙКИ НА АЛЕКСА

Стъпка 1: Инсталирайте приложението "Amazon Alexa" чрез App Store (iOS) или Play Store (Андроид) и се регистрирайте. Ако имате съществуващ профил в Amazon Alexa, моля влезте в него.

Стъпка 3: Натиснете  Settings (настройки) и натиснете "Skills & games", както е показано по-долу.

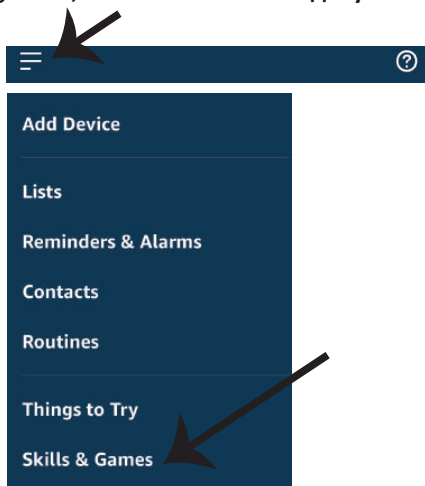

Стъпка 2: След като сте на началната страница на Amazon Alexa, натиснете долната дясна икона — накъдето е насочена стрелката — за добавяне на ново устройство и позволяване на умение.

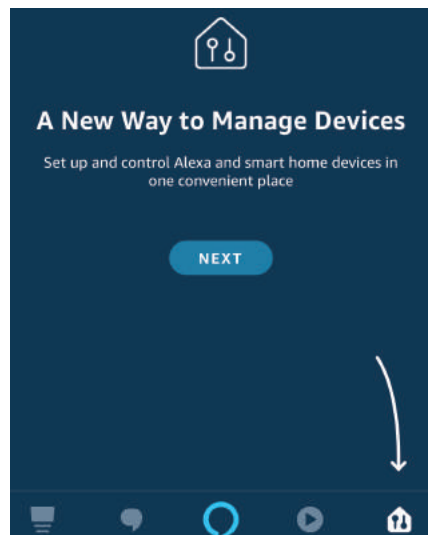

Стъпка 4: Потърсете 'V-TAC Smart Light' на страницата "Skills & Games", както е показано по-долу.

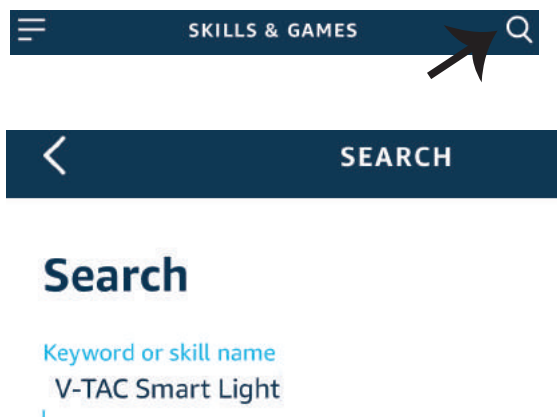

Стъпка 5: Позволете умението.

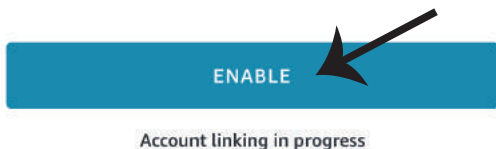

Стъпка 6: Въведете потребителското име и паролата за вход в V-TAC Smart Light и натиснете "Link Now".

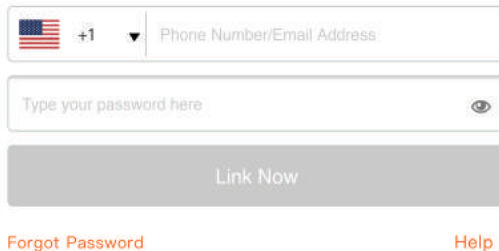

Стъпка 7: След като натиснете Link Now, ще бъдете пренасочени към нова страница, която изисква оторизация (вж. фигурата по-долу). Натиснете "Authorize".



Alexa by Amazon will be able to:

- Receive your public profile
- Control your devices over internet

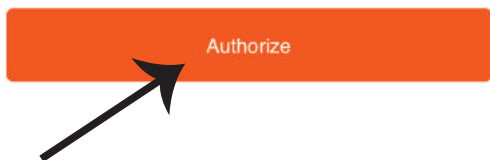

Стъпка 8: Ще получите потвърждение за успешно свързвания акаунт (вж. фигурата по-долу).

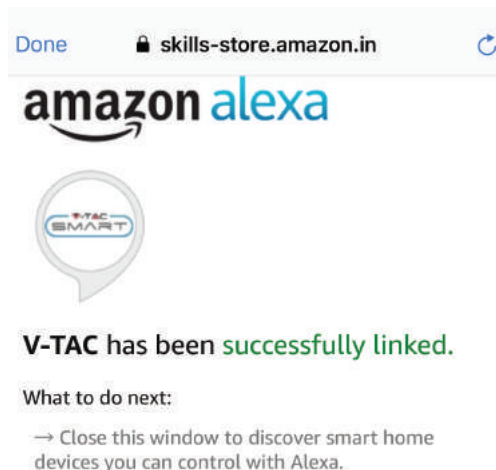

Стъпка 9: Открийте Вашето смарт устройство на Alexa. След като разрешите възможността,
A) Можете да подадете гласовата команда “Alexa discover devices” към Вашето устройство Alexa.

B) За да добавите устройство ръчно, в началната страница натиснете  и след това Add device, изберете устройството, което искате да добавите, и натиснете Discover device.

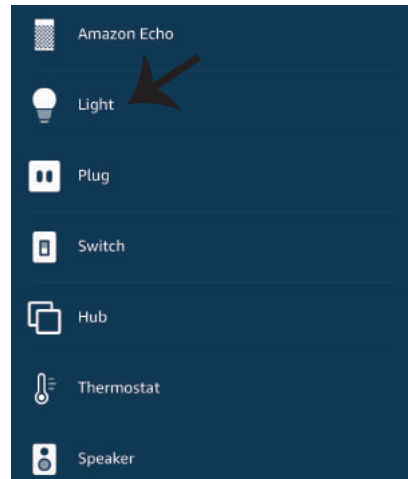
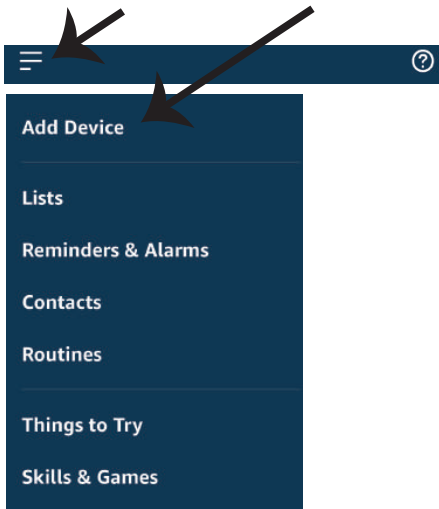

Забележка: Откриването на устройството трябва да бъде осъществено всеки път, когато името на устройството бъде променено в приложението.

КОМАНДИ НА АЛЕКСА

Сега можете да контролирате вашето умно устройство, като използвайте гласови команди на Алекса. По-долу са няколко команди, които вие можете да използвате:

- ! *Alexa, turn on/off bedroom light.*
- ! *Alexa, set bedroom light to 50 percent.*
- ! *Alexa, set bedroom light to green.*
- ! *Alexa, set bedroom light to warm white.*

НЕЩА, КОИТО ТРЯБВА ДА ЗАПОМНИТЕ ПРЕДИ ДА ЗАПОЧНЕТЕ ИНСТАЛАЦИЯ:

1. Приложение "V-TAC Smart Light" & "Amazon Alexa"
2. Уверете се, че имате устройство "Amazon Alexa" (включително Echo, Echo Tap или Echo Dot)
3. Умно устройство – Лампа
4. Стабилна Wifi мрежа

НАСТРОЙКИ GOOGLE HOME

Стъпка 1:

- a) и b) Инсталирайте приложение "Google Home" чрез App Store (iOS) или Play Store (Андроид) и се регистрирайте. Ако вече имате профил в "Google Home", моля влезте в него.
 c) Създаване на нов дом/Избор от съществуващ дом, ако има такъв.
 d) Включете в захранването устройството "Google Home" и го свържете с приложението. (След това продължете към стъпка 2)

a. Welcome home

Your content and devices all in one place



[GET STARTED >](#)

b. Choose account

This account will be used to personalize your experience

c. Choose a home

You will be able to control the devices and services in this home.



Create another home

d. Plug in your device

Make sure your device is nearby and connected to power, then try again

Стъпка 2: След като сте на страница "Google Home", натиснете иконата Добавяне "+" – за да добавите ново устройство и умение. След това натиснете "Настройка на устройство", както е показано на изображението по-долу.

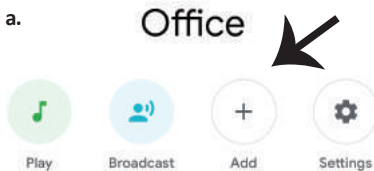

Office
1 device

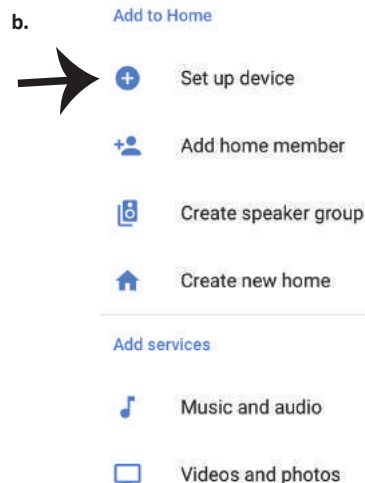
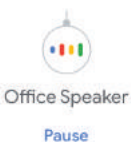

Стъпка 3: Уверете се, че "Умната крушка" е свързана с приложение "V-TAC Smart Light", преди да започнете стъпка 3. Натиснете раздела за стрела, както е подчертано в изображението по-долу.

Set up

Set up new devices or add existing devices and services to your home

New devices



Set up new devices

Google Home, smart displays and devices labelled 'Made for Google' such as C by GE smart bulbs

Works with Google



Have something already set up?

Link your smart home services such as Philips Hue and TP-Link

Стъпка 5: Влезте с вашите данни за вход "V-TAC Smart Light", за да се свържете с устройство "Умно осветление".

+1 ▼

👁️

Link Now

[Forgot Password](#)

[Help](#)

Стъпка 4: Напишете "V-TAC Smart Light" в лентата за търсене и натиснете иконата "V-TAC Smart Light".



V-TAC Smart Life

Стъпка 6: Изберете "V-TAC Smart Light", както е посочено по-долу и натиснете "Свързване сега".



Google will be able to:

Receive your public profile
Control your devices over internet

Authorize

Стъпка 7:



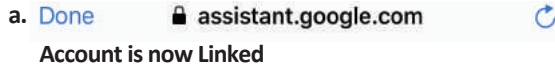
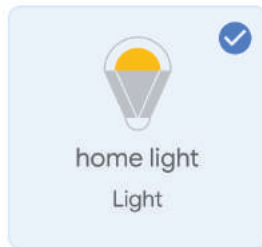

- a. Профилът ще бъде свързан, моля останете на страницата и след няколко секунди ще бъдете пренасочен, за да изберете устройството, което да добавите към вашия дом.
 б. Изберете устройството и натиснете Следващо (както е показано в изображение б).

b.  Choose device

Стъпка 8: Изберете "Дом", мястото където желаете да добавите умното осветление. (или) можете да създадете "Нов дом", за да добавите към него умното осветление.

Choose a home

You will be able to control the devices and services in this home.

-  Smart-Home
-  Office
-  Smart Home
-  Create another home

Стъпка 9: Вие успешно сте добавили устройство "Умно осветление" към вашето приложение "Google Home".

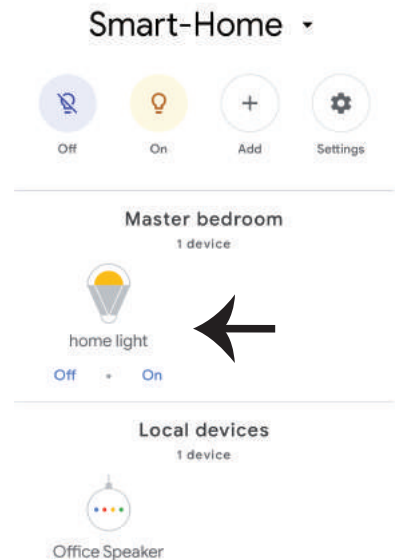

Стъпка 10:

- a. Можете да включите/изключите лампата чрез избор на опции включено/изключено (както е посочено визображение а). (ИЛИ) Вие можете да натиснете умната лампа.
- b. Ще бъдете пренасочени към страницата (както е показано на изображение b), където можете да контролирате светлините "Функционалност за включване и затымнение".

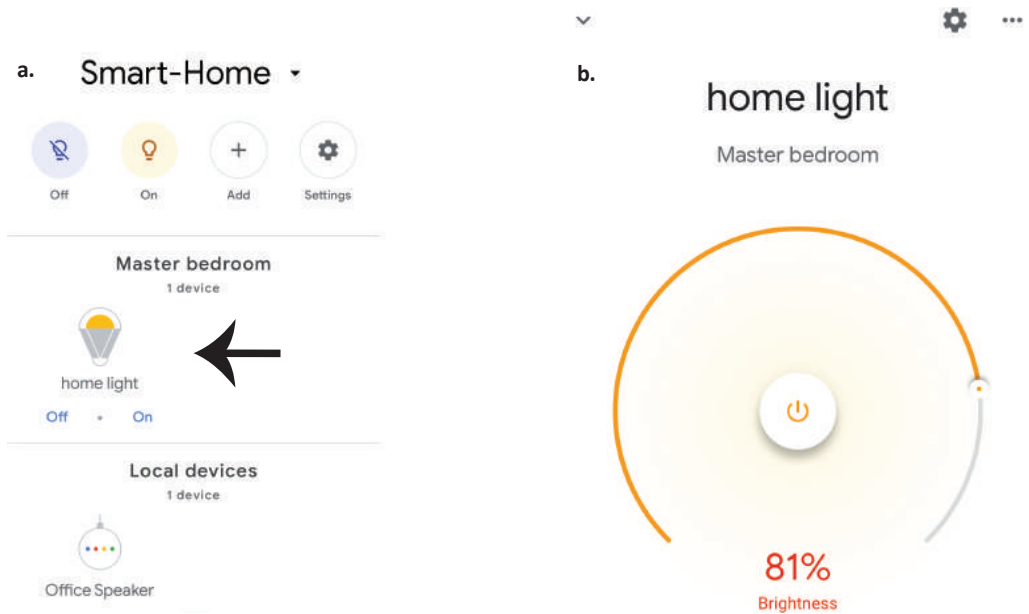
**Команди на Google:**

Сега можете да контролирате вашето умно устройство като използвате гласови команди на "Google Home". По-долу има няколко команди, които можете да използвате:

- ! *OK Google, turn on/off bedroom light*
- ! *OK Google, set bedroom light to 50 percent.*
- ! *OK Google, set bedroom light to green.*
- ! *OK Google, set bedroom light to warm white.*

КАКВО ДА НЕ ЗАБРАВЯМЕ ПРЕДИ ДА СТАРТИРАМЕ ИНСТАЛАЦИЯТА:

1. Приложение "V-TAC Smart Light" и Приложение "Google Home"
2. Уверете се, че имате устройството "Google Home"
3. Умно устройство – Лампа
4. Стабилна Wifi мрежа

UPUTE ZA UGRADNJU

- 1) Prije početka ugradnje, molimo isključite napajanje (pogledajte sliku-Dio 1).
- 2) Okrenite i uklonite poklopac (pogledajte sliku-Dio 2).
- 3) Izbušite rupu na stropu kako biste svjetiljku pričvrstili vijcima (pogledajte sliku-Dio 3).
- 4) Spojite žice (pogledajte sliku-Dio 4) prije nego što vijcima pričvrstite svjetiljku na strop.
- 5) Okrenite i blokirajte poklopac na svjetiljci (pogledajte sliku-Dio 5)
- 6) Uključite napajanje i probajte dali svjetiljka koju ste ugradili funkcionira pravilno.

SIGURNOSNO UPOZORENJE

- 1) Svjetiljke su isključivo za uporabu u zatvorenim prostorijama, te nisu preporučljive za vlažne sredine
- 2) Svjetiljke i lanterns ne mogu se montirati na površini običnih zapaljivih materijala jer je povećanje temperature normalna pojava tijekom njihovog rada.
- 3) Ne vršite vanjski pritisak i ne bacajte predmete na svjetiljku.
- 4) Svetiljke se čuvaju na hladnom/ suhom mjestu. Uvijek provjerite da li je okolina čista prije nego što montirate svjetiljku.
- 5) Ne bacajte žarulje uz obično smjeće. Svjetiljke sadrže elektroničke komponente te trebaju se deponirati na odložiti na odgovarajuća mjesta za elektronički otpad.

APP INSTALACIJA

Korak 1: Skenirajte QR kod ili preuzmite 'V-TAC Smart Light' iz App Store-a (iOS) u Google Play Store-u (Android).

For ANDROID



For IOS



Korak 4.: Otvorite aplikaciju V-TAC Smart Light i kliknite Register (registriranje) da biste registrirali novi račun (account).

V-TAC Smart Light

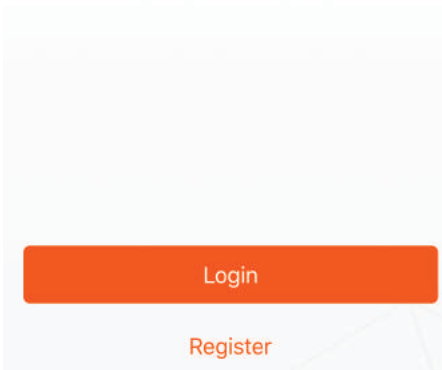

Korak 5.:

A) Broj mobitela: Odaberite svoju zemlju i unesite broj mobilnog telefona. Zatim pritisnite 'Next'.

B) E-mail: Unesite adresu e-pošte i pritisnite 'Next'.

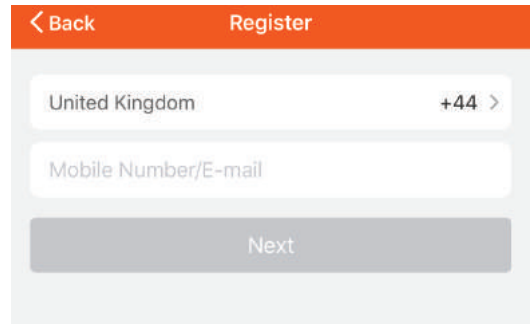

Korak 6.: Unesite kontrolni kôd koji će Vam biti poslan na mobilni telefon / e-poštu, zatim odredite novu lozinku svome računu i kliknite "Conform".

Korak 7: Pređite na 'Add Device' ili na znak +. Provjerite da li je svjetiljka uključena.

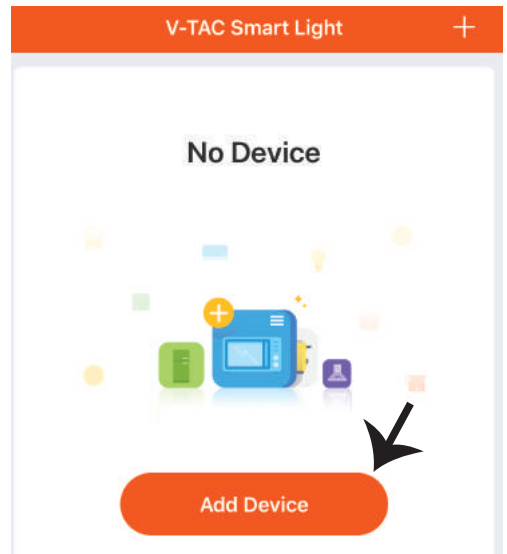
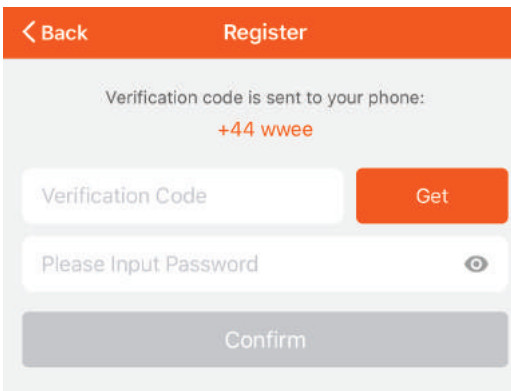

Korak 8: Odaberite "Rasvjetni uređaji" da biste uparili žarulju s aplikacijom.

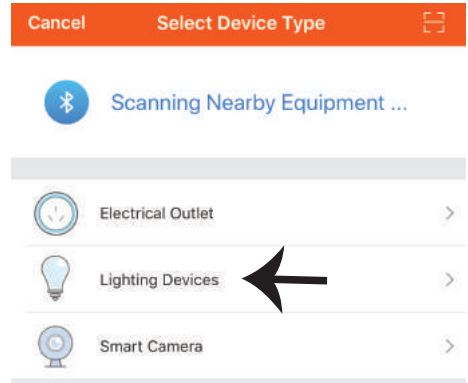

Korak 9: Za uparivanje uređaja sa svjetiljkom, provjerite da li svjetlo brzo treperi.

Nakon što svjetiljka počne ubrzano da treperi, to je znak da je ista u režimu povezivanja. Ako svjetiljka ne treperi ubrzano, možete izvršiti jednu od sljedećih radnji:

- A. Naizmjenično isključite i uključite žarulju 3 puta, u intervalima od manje od 2 sekunde.
- B. Pređite na vezu 'Kako da svjetlo treperi brzo' (kao što je prikazano na slici).

Mrežni načini rada:

- 1) EZ Način: Svjetlo treperi dvaput u sekundi
- 2) AP način: Svjetlo treperi sporo, jednom u 2 sekunde

Na strani "Dodaj uređaj" potvrdite da li je žarulja u EZ načinu. Ako nije, možete odabrati EZ način uključivši uređaj tri puta.

Provjerite da li svjetlo svjetluca brzo, odaberite bežičnu mrežu te unesite zaporku.

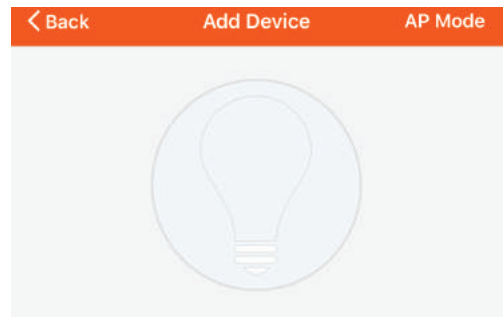
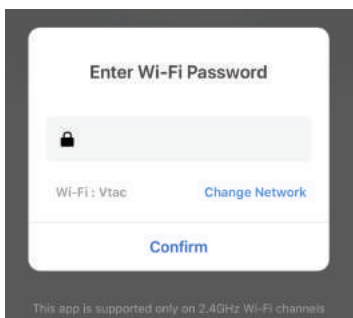

Power on the light and confirm that light blinks rapidly

[How to make light blinks rapidly](#)

Confirm light blinks rapidly

Korak 10.: Nakon uspješnog završetka koraka 9, bit ćete preusmjereni na donju stranicu na kojoj aplikacija pretražuje, registrira i inicijalizira uređaj (svjetiljku) (vidi sliku ispod).

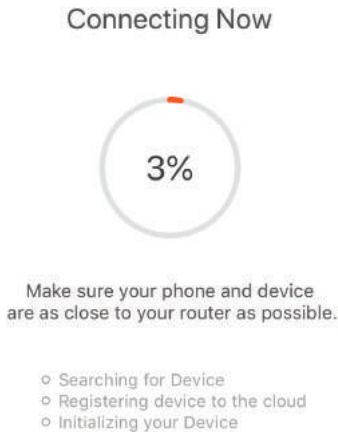

Korak 11: Kada je Vaš uređaj uspješno dodan, promijenite njegovo ime po vlastitom nahođenju.

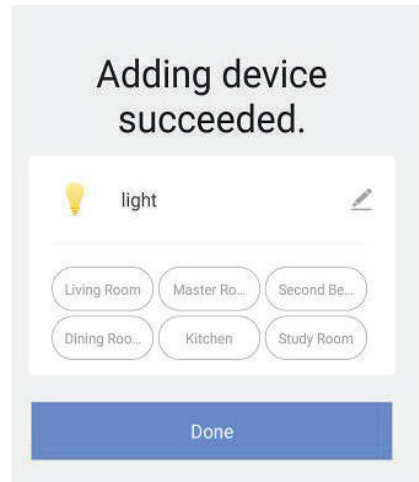

Korak 12: Nakon što uspješno sinkronizirate svjetiljku s aplikacijom, onda možete upravljati različitim značajkama svjetiljke putem mobilnog telefona, kao što je: uključivanje / isključivanje, promjena temperaturu boje, sinkronizaciju i grafike, opcija prigušivanja i još mnogo toga.

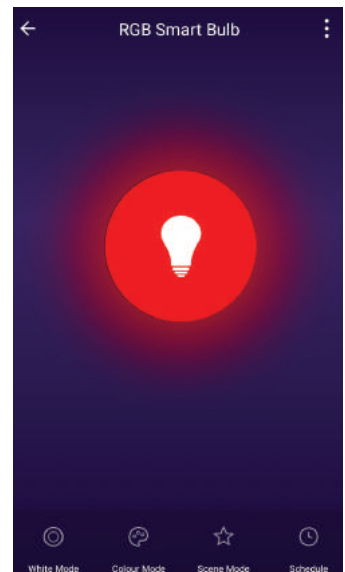
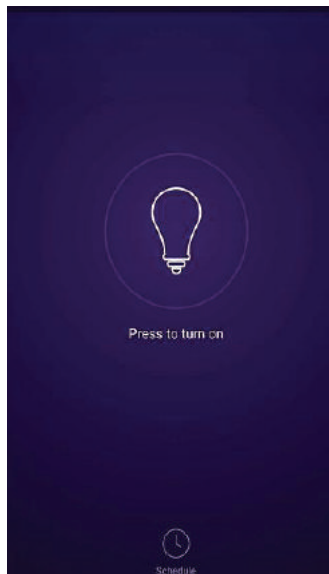
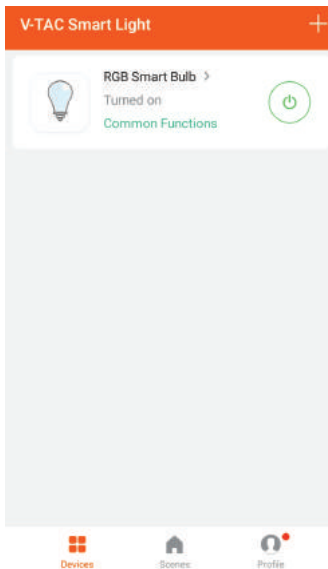

POSTAVKE ZA ALEXA

Korak 1: Instalirajte Amazon Alexa aplikaciju s App Store-a (iOS) ili Play Store-a (Android) i registrirajte ju. Ako već imate račun za Amazon Alexa, jednostavno se prijavite.

Korak 2: Kada dođete na domaću stranicu Amazon Alexa, pritisnite donju desnu ikonu — kuda ukazuje strelica — da biste dodali novi uređaj ili vještinu.

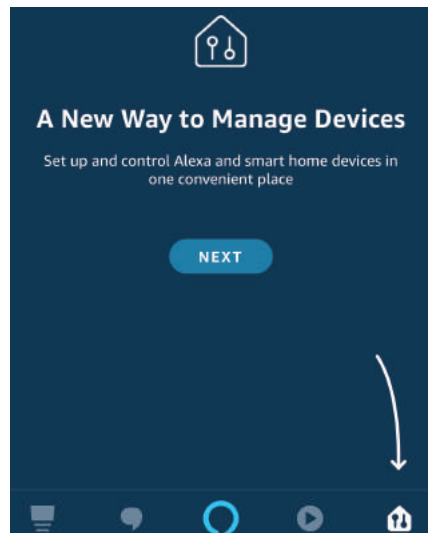

Korak 3.: Pritisnite  Settings (postavke) i kliknite "Skills & games" kao što je prikazano ispod.

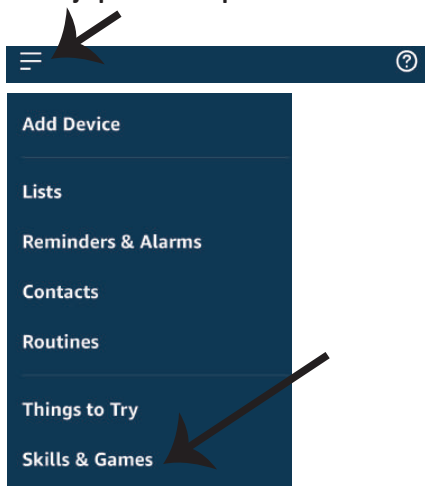

Korak 4.: Potražite „V-TAC Smart Light“ na stranici "Skills & games" kao što je prikazano ispod.

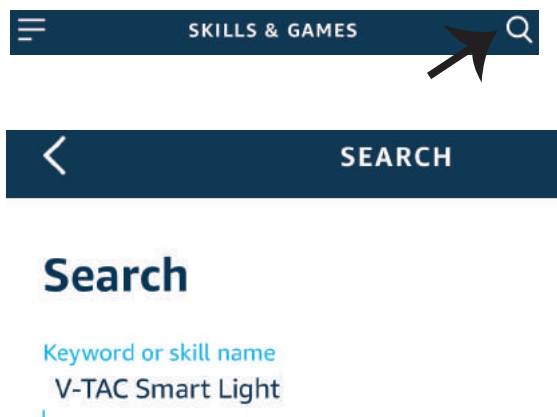

Korak 5: Aktivirajte Vještinu.

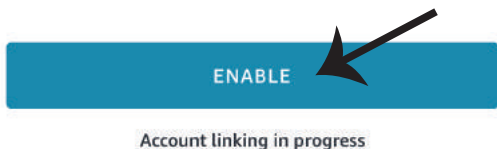

Korak 6.: Unesite korisničko ime i lozinku za „V-TAC Smart Light“ i kliknite "Link Now".

Korak 7.: Nakon što kliknete "Link Now" bit ćete preusmjereni na novu stranicu koja zahtijeva autorizaciju (pogledajte sliku u nastavku). Pritisnite "Authorize".



Alexa by Amazon will be able to:

- Receive your public profile
- Control your devices over internet



Korak 8.: Dobit ćete potvrdu o uspješno povezanom računu (pogledajte sliku u nastavku).

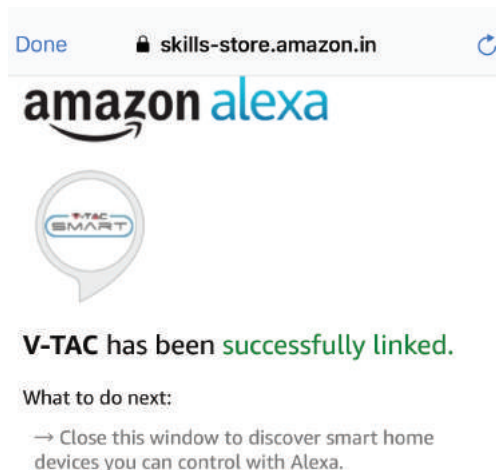

Korak 9. Otkrijte Vaš pametni uređaj u Alexa. Nakon što odobrite opciju:

A) Možete dati glasovnu naredbu „Alexa discover devices“ Vašem uređaju Alexa.

B) Da biste ručno dodali uređaj, na početnoj stranici pritisnite  , a zatim Add devices, odaberite uređaj, koji želite dodati, i pritisnite Discover device.

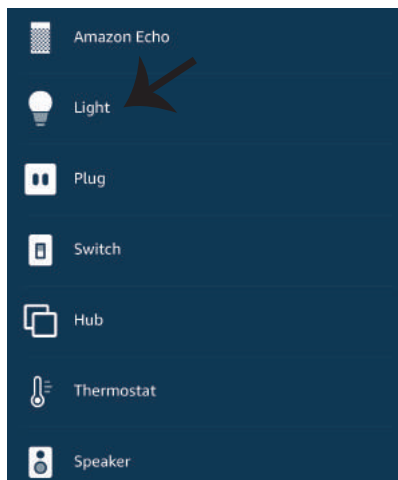
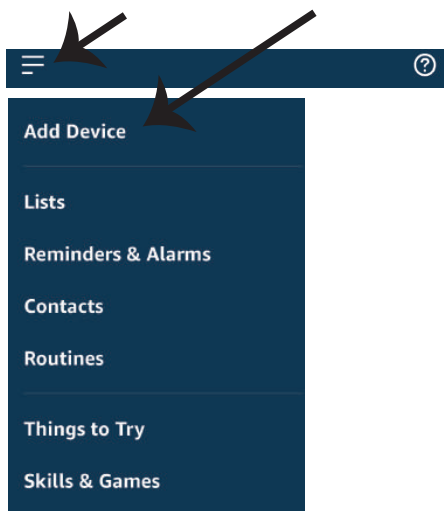

Napomena: Uređaj morate pronaći svaki put kada promjenite njegovo ime na aplikaciji

ALEXA Naredbe

Sada možete kontrolirati Vaš pametni uređaj pomoću glasovnih naredbi na Alexa. Ispod ćete naći nekoliko naredbi koje možete koristiti:

- ! *Alexa, turn on/off bedroom light.*
- ! *Alexa, set bedroom light to 50 percent.*
- ! *Alexa, set bedroom light to green.*
- ! *Alexa, set bedroom light to warm white.*

PRIJE POČETKA INSTALACIJE NEMOJTE ZABORAVITI:

1. Aplikaciju V-TAC Smart Light i aplikaciju Amazon Alexa
2. Uvjerite se da imate uređaj Amazon Alexa (uključujući Echo, Echo Tap, ili Echo Dot)
3. Pametni uređaj – Svjetiljku
4. Stabilnu Wifi mrežu

GOOGLE HOME POSTAVKE

Korak 1:

a&b) Instalirajte aplikaciju Google Home s App Store-a (iOS) ili Play Store-a (Android) i registrirajte ju. Ako već imate račun za Google Home, jednostavno se prijavite.

c) Napravite novi Home/Odaberite postojeći, ukoliko postoji.

d) Uključite uređaj Google Home ai povežite ga s aplikacijom. (Zatim nastavite s korakom 2)

a. Welcome home

Your content and devices all in one place



GET STARTED >

b. Choose account

This account will be used to personalize your experience

c. Choose a home

You will be able to control the devices and services in this home.



Create another home

d. Plug in your device

Make sure your device is nearby and connected to power, then try again

Korak 2: Čim dođete do Googlove početne stranice, pritisnite ikonu Dodaj(“+”) da biste dodali novi uređaj ili vještinu. Zatim pređite na “Postavi uređaj” kao što je prikazano na slici ispod.

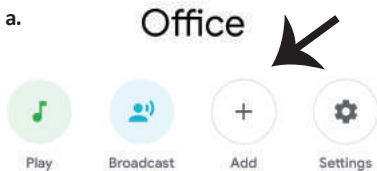

Office
1 device



Office Speaker

Pause

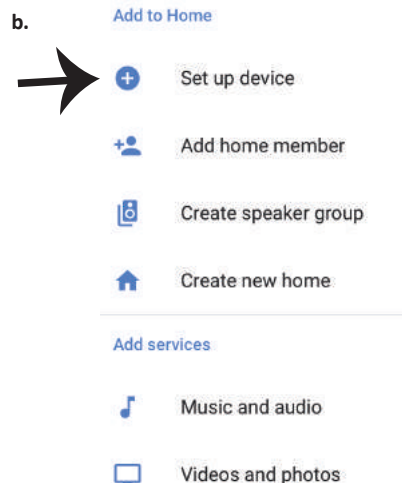

Korak 3: Uvjerite se da je Pametna žarulja uparena s aplikacijom V-TAC Smart Light prije nego prijeđete na korak 3. Pritisnite strelicu kao što je prikazano na slici ispod.



Korak 4.: Upišite "V-TAC Smart Light" u traku za pretraživanje i pritisnite ikonu "V-TAC Smart Light"

Set up
Set up new devices or add existing devices and services to your home

New devices

 **Set up new devices**
Google Home, smart displays and devices labelled 'Made for Google' such as C by GE smart bulbs

Works with Google

 **Have something already set up?** 
Link your smart home services such as Philips Hue and TP-Link



Korak 5: Prijavite se sa svojim V-TAC Smart Light vjerodajnicama da biste uključili Smart Light uređaj

Korak 6: Odaberite V-TAC Smart Light kao što je prikazano ispod i pritisnite Poveži sada (Link Now).

 +1



Link Now

[Forgot Password](#) [Help](#)





Google will be able to:
Receive your public profile
Control your devices over internet

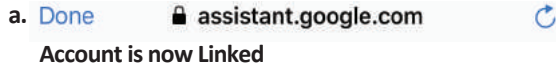

Korak 8:

- a. Računi će biti povezani, ostanite na strani te ćete za par sekundi biti preusmjereni na odabir domaćeg uređaja.
- b. Odaberite uređaj i pritisnite Dalje (kao što je prikazano na slici b).





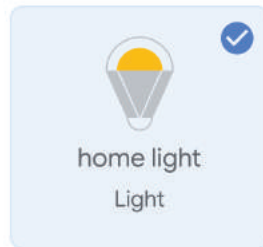

b.  Choose device



Korak 9: Odaberite Home, kojem ćete dodati Smart Light (ili) možete napraviti novi Home kojem ćete dodati Smart Light.

Choose a home

You will be able to control the devices and services in this home.

-  Smart-Home
-  Office
-  Smart Home
-  Create another home

Korak 10: Uspješno ste dodali uređaj Smart Light svojoj Google Home aplikaciji.

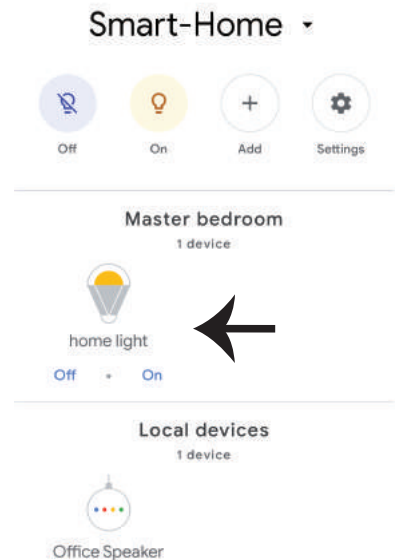

Korak 10:

- a. Možete uključiti/ isključiti svjetiljku birajući opcije “Uključi / Isključi” (kao što je prikazano na slici a). (ILI) Možete pritisnuti na “Smart Light”.
- b. Bit ćete preusmjereni na stranicu (kao što je prikazano na slici b) s koje možete kontrolirati svjetlost “Funkcija rasvjete i zatamnivanja”.

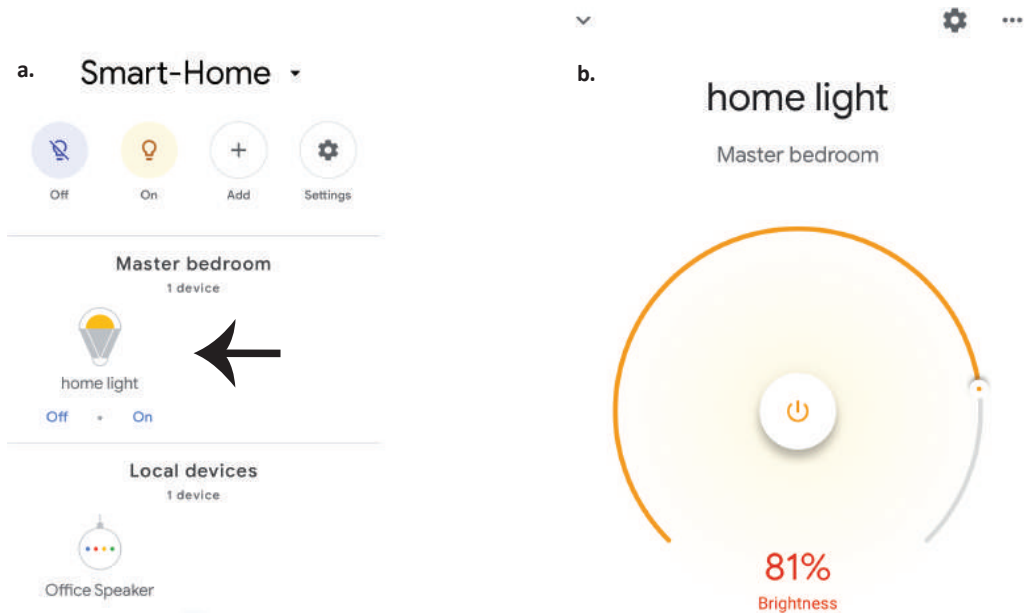
**Google Naredbe:**

Sada možete kontrolirati Vaš pametni uređaj pomoću glasovnih naredbi na Google Home. Ispod ćete naći nekoliko naredbi koje možete koristiti:

- ! *OK Google, turn on/off bedroom light*
- ! *OK Google, set bedroom light to 50 percent.*
- ! *OK Google, set bedroom light to green.*
- ! *OK Google, set bedroom light to warm white.*

PRIJE POČETKA INSTALACIJE NEMOJTE ZABORAVITI:

1. Aplikaciju V-TAC Smart Light i aplikaciju Google Home
2. Provjerite da li imate uređaj Google Home
3. Pametni uređaj - svjetiljku
4. Stabilnu Wifi mrežu

INSTRUÇÕES DE INSTALAÇÃO

- 1) Antes de começar a instalação, desligue a fonte de alimentação (veja a figura Parte 1).
- 2) Gire e remova a tampa (veja a figura Parte 2).
- 3) Faça um furo no teto para fixar a lâmpada com a ajuda de parafusos (veja a figura Parte 3).
- 4) Ligue os fios (ver Figura 4) antes de fixar a lâmpada no teto com os parafusos.
- 5) Gire e trave a tampa na lâmpada (veja a figura Parte 5)
- 6) Ligue a fonte de alimentação e teste a lâmpada.

AVISO DE SEGURANÇA

- 1) As lâmpadas são limitadas para uso interno e não é recomendado para utilizá-las em ambientes húmidos
- 2) As lâmpadas e as lanternas não podem ser instaladas na superfície de materiais combustíveis comuns. Aumentar a temperatura é comum para as lâmpadas.
- 3) Não exerce força externa nem lance a lâmpada.
- 4) As lâmpadas devem ser armazenadas em lugar fresco/seco. Certifique-se sempre que o ambiente está limpo antes de instalar a lâmpada.
- 5) Não elimine as lâmpadas com o lixo normal. As lâmpadas são feitas de componentes eletrônicos e devem ser adequadamente descartadas em locais designados para tratamento unificado, como por exemplo, para equipamentos eletrônicos tradicionais.

APP INSTALAÇÃO

Passo 1: Digitalize o código QR indicad ou baixe "V-TAC Smart Light" a partir da App Store (iOS) ou "Google Play Store" (Android).

For ANDROID



For IOS



Passo 4: Abra o aplicativo V-TAC Smart Light e clique em registar para criar uma nova conta

V-TAC Smart Light

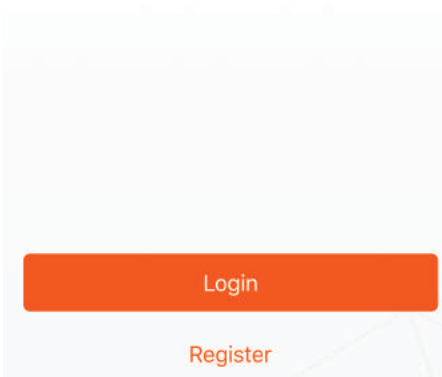

Passo 5:

A) Número do telemóvel: Selecione o país e insira o número do seu telemóvel. Quando terminar, clique em "Seguir".

B) E-mail: Digite seu ID de e-mail e toque em "Seguir".

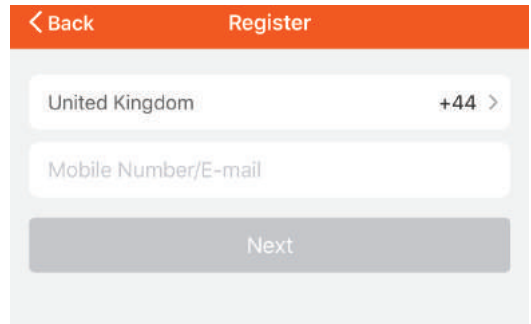

Passo 6: Introduza o código de verificação que será enviado para o seu número de telemóvel / ID de email, depois atribua uma nova senha à sua conta e toque em "Confirmar".

Passo 7: Clique em "Adicionar um dispositivo" ou o símbolo +. Assegure-se que a lâmpada está ligada.

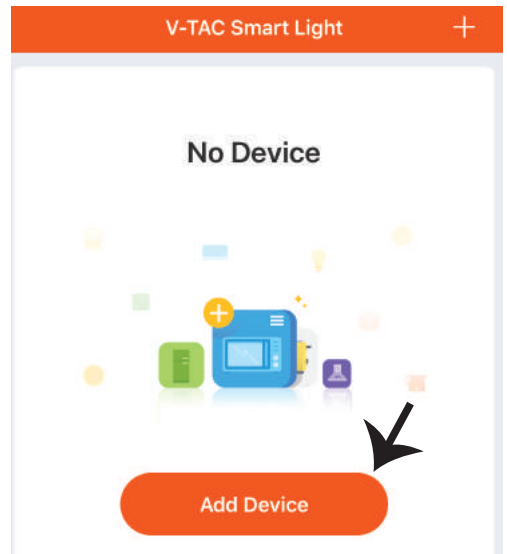
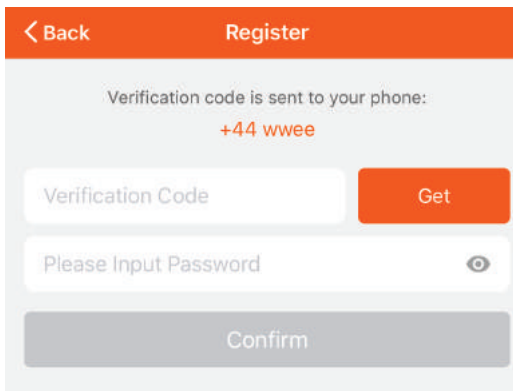

Passo 8: Selecione "Dispositivos para iluminação" para começar a conectar a lâmpada com a aplicação.

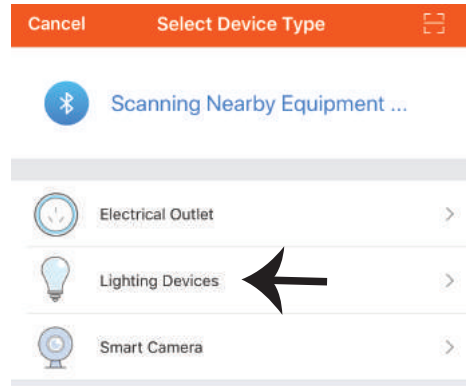

Passo 9: Para conectar o dispositivo com a lâmpada, certifique-se que a luz pisca rapidamente.

Quando a luz pisca rapidamente, a lâmpada está no modo de emparelhamento. Se a lâmpada não estiver piscando rapidamente, você pode executar um dos seguintes passos:
A. Ligue e desligue a lâmpada 3 vezes em intervalos curtos com menos de 2 segundos.
B. Pressione o link «Como fazer as luzes piscar rapidamente» (como mostrado na imagem)

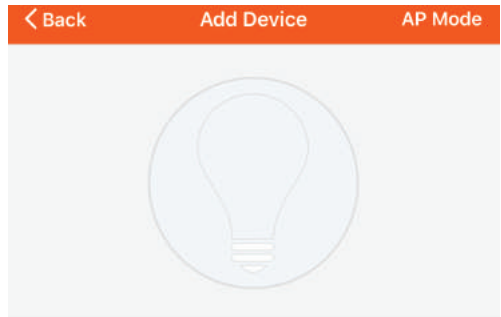

Power on the light and confirm that light blinks rapidly

Modos da Rede:

- 1) Modo EZ: A luz pisca duas vezes por segundo
- 2) Modo AP: Pisca lentamente, uma vez cada 2 segundos.

Na página "Adicionar dispositivo", confirme se a lâmpada está no modo EZ. Se não está, pode alternar para o modo EZ ligando o dispositivo três vezes.

Confirme se a luz pisca rápido, selecione a rede WiFi e insira a senha.

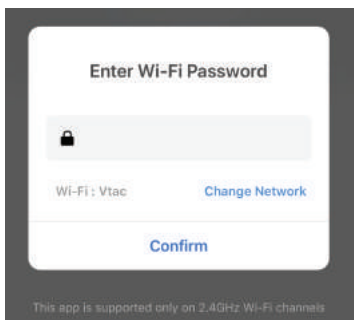

Passo 10: Depois de concluir com sucesso o passo 9, você será redirecionado para a página abaixo, onde o aplicativo pesquisa, regista e inicializa o dispositivo (lâmpada) (ver imagem abaixo)

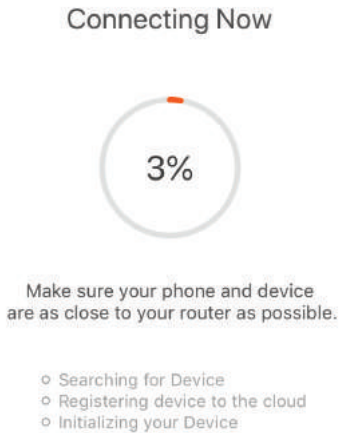

Passo 11: Depois de o seu dispositivo estar adicionado com êxito, renomeie o dispositivo como preferir.

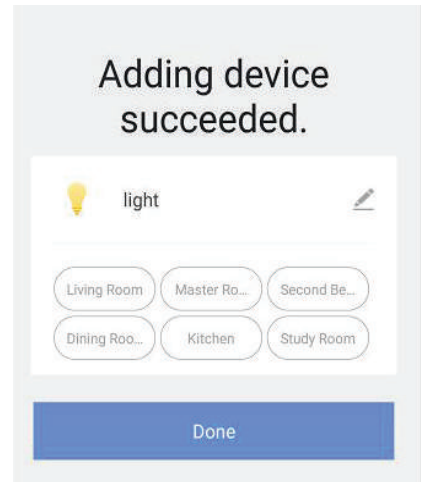

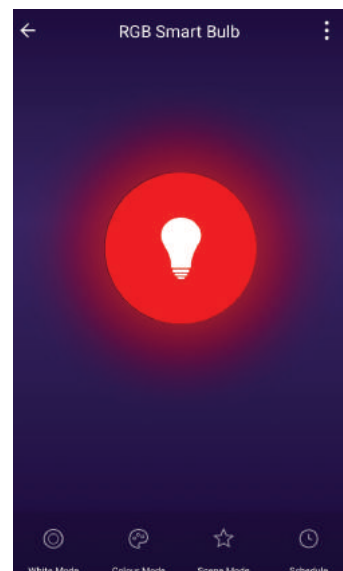
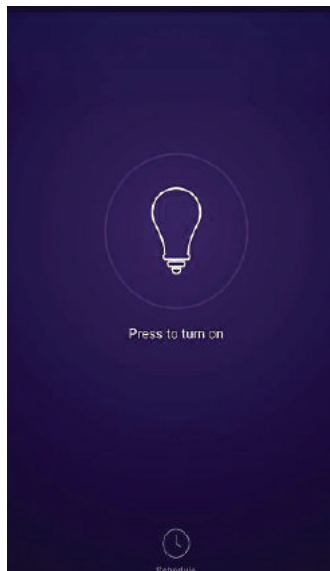
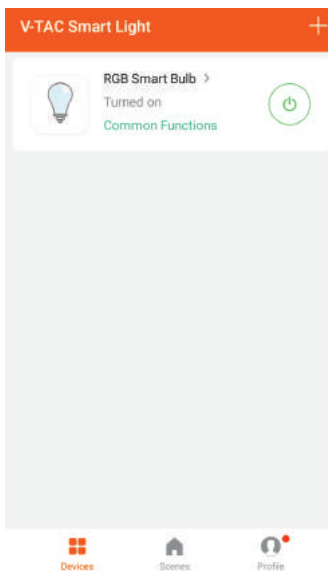

Passo 12: Depois de emparelhar com sucesso a lâmpada com o aplicativo, pode começar a controlar vários recursos da lâmpada através do seu telemóvel - interruptor de ligar/desligar, alterar a temperatura da cor, tempo e horários, opções de escurecimento e muito mais.

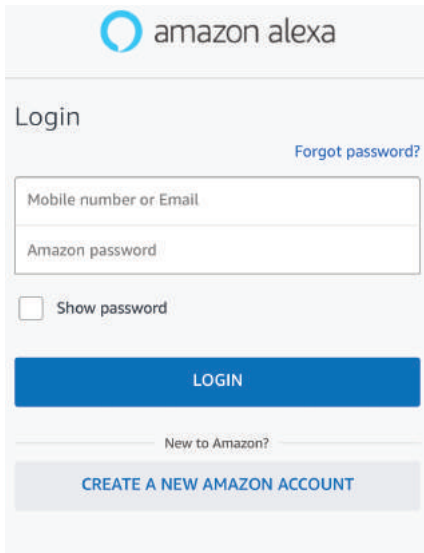

CONFIGURAÇÕES ALEXA

Passo 1: Instale o aplicativo "Amazon Alexa" através da App Store (iOS) ou Play Store (Android) e registre-se. Se já tem uma conta existente no Amazon Alexa, por favor, entre nela.



Passo 3: Clique em  Settings e clique em "Skills & Games" (habilidades e jogos), como mostrado abaixo.

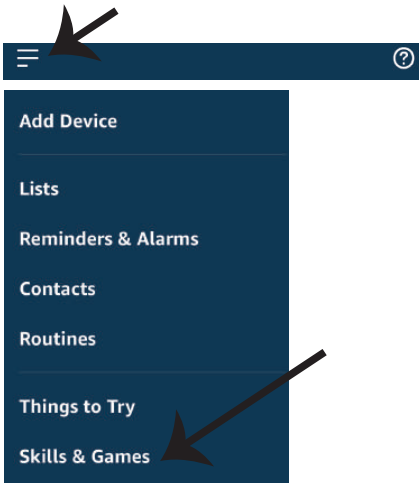

Passo 2: Quando estiver na página inicial do Amazon Alexa, pressione o ícone à direita em baixo – para onde a seta é direcionada – a fim de adicionar um novo dispositivo e permitir uma habilidade.

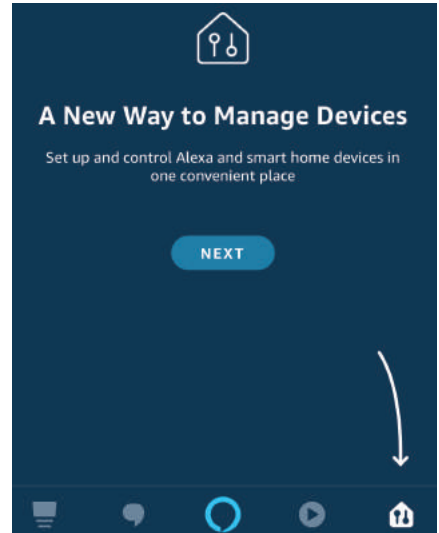

Passo 4: Pesquise "V-TAC Smart Light" na página "Skills & Games" como mostrado abaixo

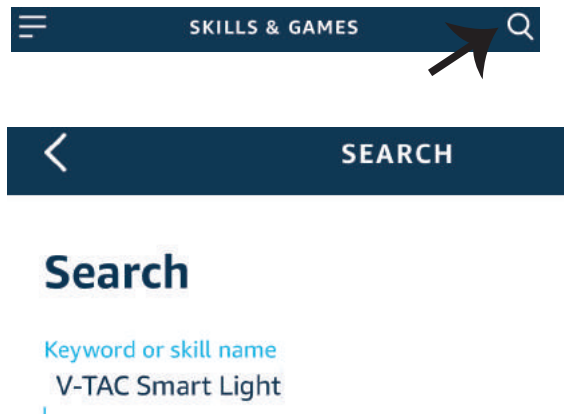

Passo 5: Autoriza a habilidade.

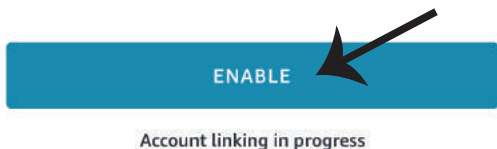

Passo 6: Insira o seu ID de login e senha de V-TAC Smart Light e clique em "Link Now"

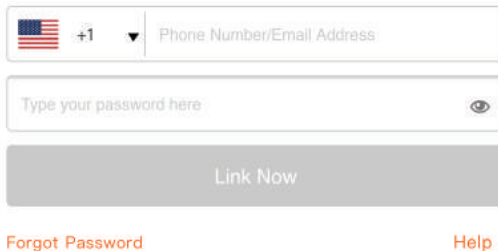

Passo 7: Ao clicar em Link Now, será redirecionado para uma nova página solicitando autorização (ver imagem abaixo). Clique em "Autorizar"



Alexa by Amazon will be able to:

- Receive your public profile
- Control your devices over internet

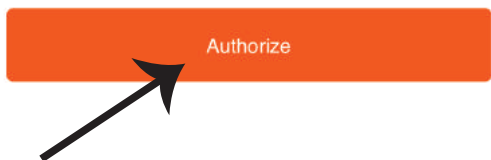

Passo 8: Receberá a confirmação de que a conta está sendo vinculada com sucesso (ver imagem abaixo)

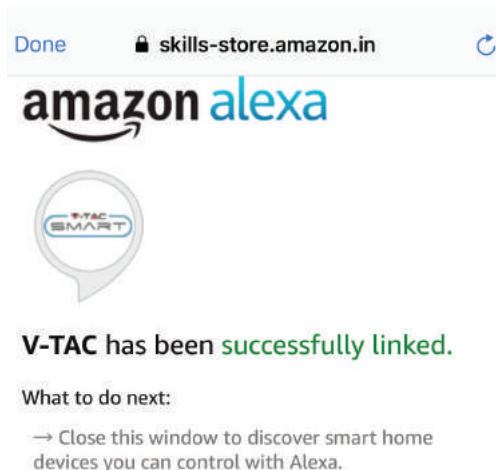

Passo 9: Descubra o seu dispositivo inteligente em Alexa. Depois de ter ativado a habilidade A) Você pode usar o comando de voz "Alexa discover devices" ("Alexa descubra dispositivos") para o dispositivo Alexa que tem.

B) Para adicionar dispositivo manualmente na página inicial, clique em  e toque em Add device, selecione o dispositivo que está a adicionar e toque em descobrir dispositivo.

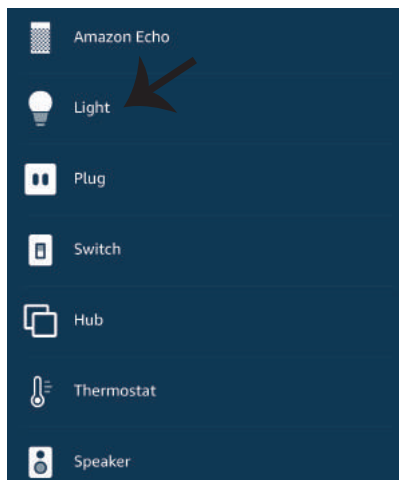
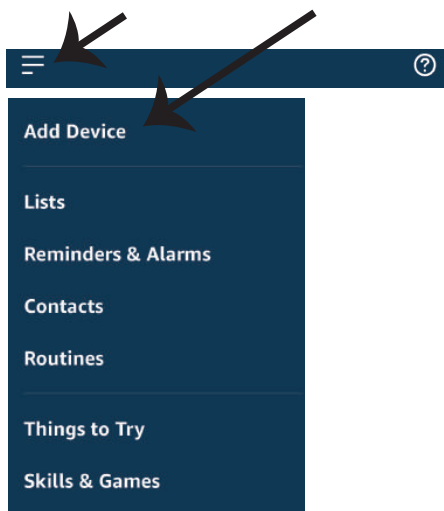

Nota: A detecção do dispositivo deverá ser realizada a cada vez quando o nome do dispositivo for alterado no aplicativo.

COMANDOS DA ALEXA

Agora poderá controlar o seu dispositivo inteligente ao usar os comandos de voz da Alexa. Abaixo estão dados alguns comandos que poderá usar:

- ! *Alexa, turn on/off bedroom light.*
- ! *Alexa, set bedroom light to 50 percent.*
- ! *Alexa, set bedroom light to green.*
- ! *Alexa, set bedroom light to warm white.*

DICAS QUE DEVERÁ MEMORIZAR ANTES DE COMEÇAR A INSTALAÇÃO:

1. Aplicação "V-TAC Smart Light" e "Amazon Alexa"
2. Assegure-se que possui um dispositivo "Amazon Alexa" (incluindo Echo, Echo Tap ou Echo Dot)
3. Dispositivo inteligente - Lâmpada
4. Rede Wifi estável

CONFIGURAÇÕES GOOGLE HOME

Passo 1:

- a) e b) Instale o aplicativo "Google Home" através da App Store (iOS) ou Play Store (Android) e registre-se. Se já tem uma conta no Google Home, por favor, entre nela.
- c) Crie uma casa nova /Escolhe a partir da casa existente, se tal existe.
- d) Ligue o dispositivo "Google Home" na alimentação e conecte-o à aplicação. (Em seguida, avance para o passo 2)

a. Welcome home

Your content and devices all in one place



GET STARTED >

b. Choose account

This account will be used to personalize your experience

c. Choose a home

You will be able to control the devices and services in this home.



Create another home

d. Plug in your device

Make sure your device is nearby and connected to power, then try again



Passo 2: Quando estiver na página "Google Home", clique no ícone Adicionar "+" para adicionar um dispositivo e habilidade novos. Em seguida, pressione "Configuração de Dispositivo", como mostrado na imagem abaixo.

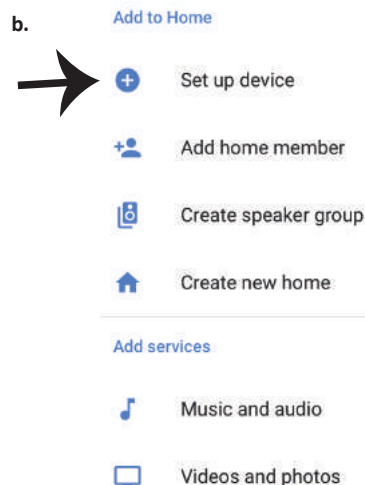
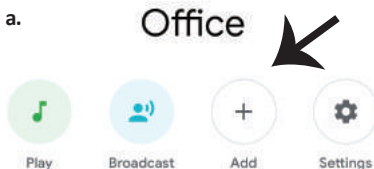

Office
1 device



Office Speaker

Pause

Passo 3: Assegure-se que a "lâmpada inteligente" está conectada com a aplicação "V-TAC Smart Light" antes de começar o passo 3. Clique no espaço da seta, como sublinhado na imagem abaixo.

Passo 4: Digite "V-TAC Smart Light" na barra de pesquisa e toque no ícone de "V-TAC Smart Light"

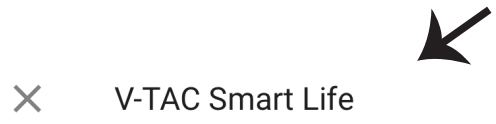
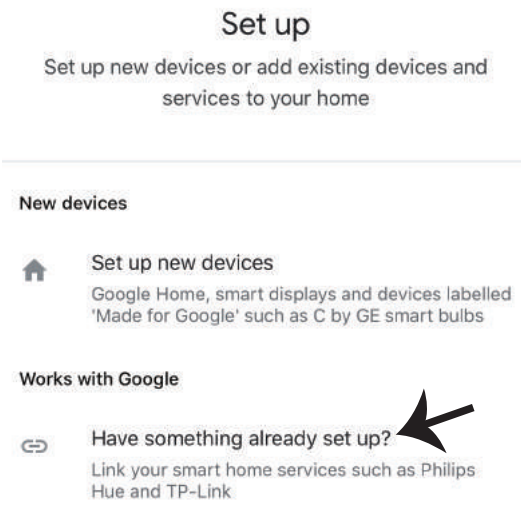

Passo 5: Inscreva-se com seus dados de login na "V-TAC Smart Light" para se conectar ao dispositivo "Luzes inteligentes".

Passo 6: Seleccione "V-TAC Smart Light", como mostrado abaixo e clique em "Conectar agora".

+1 Phone Number/Email Address

Type your password here

Link Now

[Forgot Password](#) [Help](#)



Google will be able to:
Receive your public profile
Control your devices over internet



Passo 8:

- a. O perfil será conectado, por favor, fique na página e passados alguns segundos, será redirecionado para selecionar o dispositivo que irá adicionar na sua casa.
- b. Selecione o dispositivo e pressione Seguinte (como mostrado na imagem b).

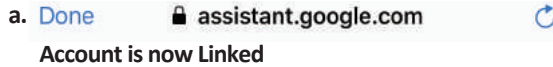



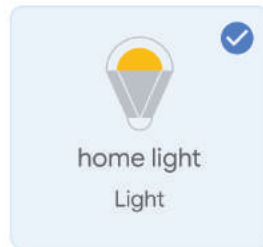

b.  Choose device



Passo 9: Seleccione "Casa", o lugar onde deseja adicionar a iluminação inteligente. (ou) poderá criar uma "Casa nova" para adicionar a ela a iluminação inteligente.

Choose a home

You will be able to control the devices and services in this home.

-  Smart-Home
-  Office
-  Smart Home
-  Create another home

Passo 10: Já adicionou com sucesso um dispositivo Iluminação Inteligente à sua aplicação Google Home.

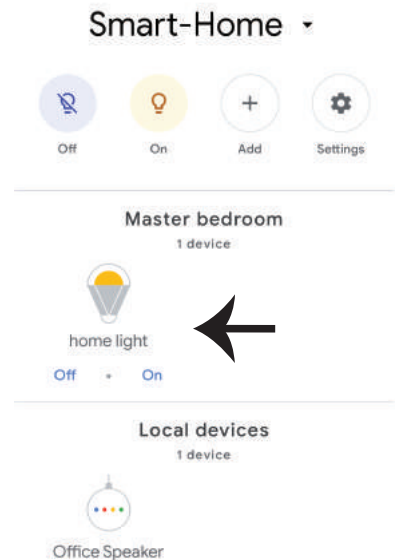

Passo 10:

- a. Poderá ligar/desligar a lâmpada selecionando as opções ligar/desligar (como mostrado na figura a). (OU) Poderá pressionar a lâmpada inteligente.
- b. Será redirecionado para a página (como mostrado na imagem b), onde poderá controlar as luzes "Funcionalidade para ligar e escurecer".

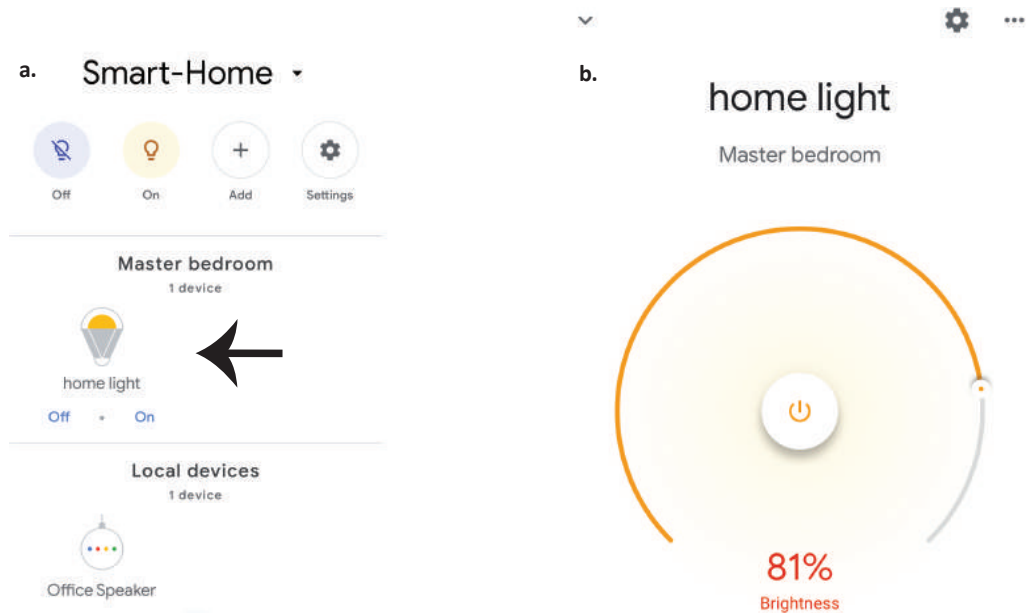
**Comandos do Google:**

Agora poderá controlar o seu dispositivo inteligente usando comandos de voz no "Google Home". Abaixo estão dados alguns comandos que poderá usar:

- ! *OK Google, turn on/off bedroom light*
- ! *OK Google, set bedroom light to 50 percent.*
- ! *OK Google, set bedroom light to green.*
- ! *OK Google, set bedroom light to warm white.*

O QUE NÃO DEVEMOS ESQUECER ANTES DE INICIAR A INSTALAÇÃO:

1. *Aplicação "V-TAC Smart Light" e Aplicação "Google Home"*
2. *Assegure-se que possui o dispositivo "Google Home"*
3. *Dispositivo inteligente*
4. *Rede Wifi estável*

INSTRUCCIONES DE INSTALACION

- 1) Antes de empezar la instalación, desconecte la fuente de alimentación.
- 2) Gire y retire la tapa (ver figura 2).
- 3) Taladre un orificio en el techo para fijar la lámpara con tornillos (ver figura 3).
- 4) Conecte los cables (ver figura 4) antes de fijar la lámpara al techo mediante los tornillos.
- 5) Gire y bloquee la tapa de la lámpara (ver figura 5)
- 6) Encienda la fuente de alimentación y pruebe la lámpara.

ADVERTENCIA DE SEGURIDAD

- 1) Las lámparas están con uso limitado en interiores y no se aconseja su uso en ambientes húmedos
- 2) Las lámparas y las linternas no se pueden instalar en la superficie de materiales combustibles ordinarios. El aumento de temperatura es normal para las lámparas.
- 3) No ejerza fuerza externa ni tire de la lámpara.
- 4) Las lámparas deben almacenarse en un lugar fresco/seco. Asegúrese siempre de que el ambiente esté limpio antes de instalar la lámpara.
- 5) No deseche las lámparas con basura normal. Las lámparas están fabricadas con componentes electrónicos y deben eliminarse adecuadamente en lugares designados con un tratamiento unificado, como los equipos electrónicos tradicionales.

APP INSTALACIÓN

Paso 1: Escanee el código QR dado, o descargue 'V-TAC Smart Light' del App Store (iOS) o del Google Play Store (Android).

For ANDROID



For IOS



Paso 4: Abra la aplicación V-TAC Smart Light y pulse en registrarse para crear una nueva cuenta

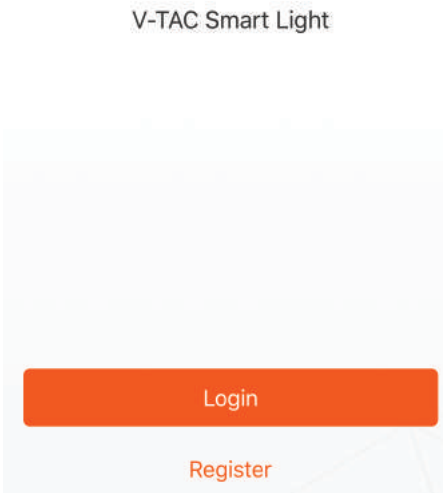

Step5:

A) Número de móvil: Seleccione el país, luego ingrese su número de móvil. Una vez hecho esto, pulse "Seguir".

B) Correo electrónico: ingrese su ID de correo electrónico y pulse "Seguir".

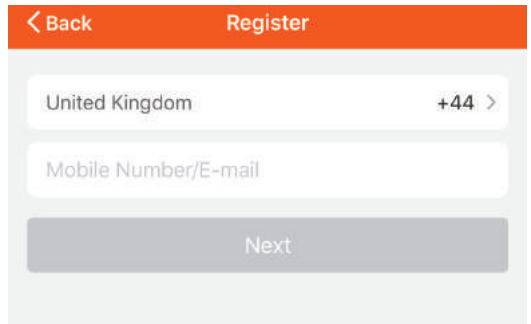

Paso 6: Ingrese el código de verificación que se enviará a su número de móvil / identificación de correo electrónico, luego asigne una nueva contraseña a su cuenta y pulse "Confirmar".

Paso 7: Toca en 'Add Device' o en el signo +. Asegúrese que la lámpara está conectada.

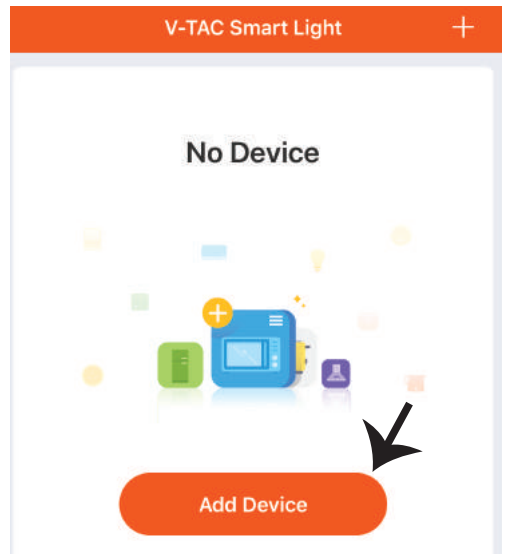
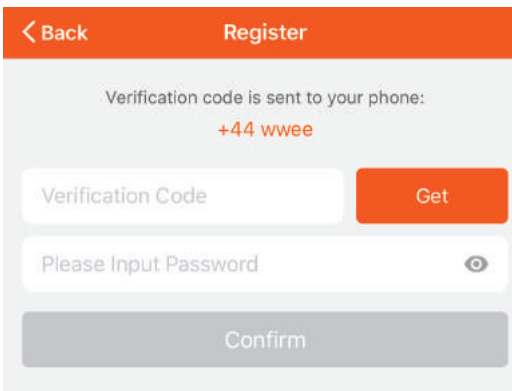

Paso 8: Escoja 'Lighting Devices' para comenzar a emparejar la lámpara a la aplicación.

Paso 9: Para emparejar el dispositivo con la lámpara, asegúrese de que la luz esté parpadeando rápidamente.

Una vez que la luz parpadea rápidamente, la lámpara está en modo de emparejamiento. Si la bombilla no parpadea rápidamente, puede realizar uno de los siguientes pasos:

- A. Encienda y apague la bombilla repetidamente 3 veces, con intervalos cortos de menos de 2 segundos.
- B. Toca el enlace 'How to make light blink rapidly' (Cómo hacer que la luz parpadee rápido) (como se muestra en la imagen)

Modos de red:

- 1) Modo EZ: La luz parpadea dos veces por segundo
- 2) Modo AP: Parpadeo lento, una vez por 2 segundos

En la página "Add device - Agregar dispositivo ", confirme si la bombilla está en modo EZ. Si no es así, puede cambiar al modo EZ por una conmutación del dispositivo en tres veces.

Confirme si la luz parpadea rápidamente, seleccione la red WiFi e introduzca la contraseña.

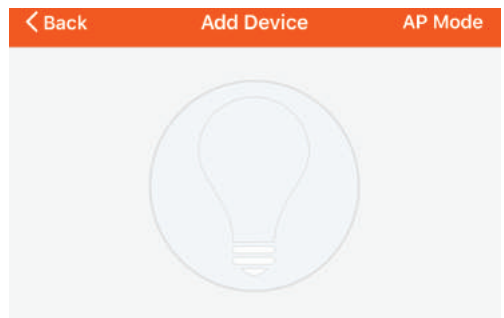
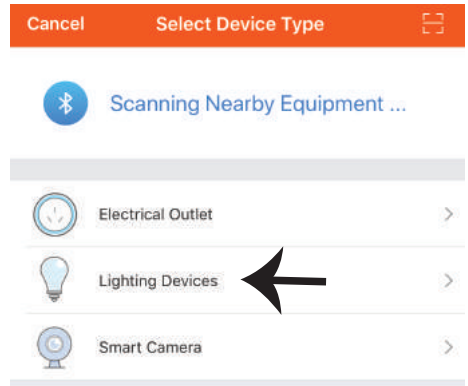
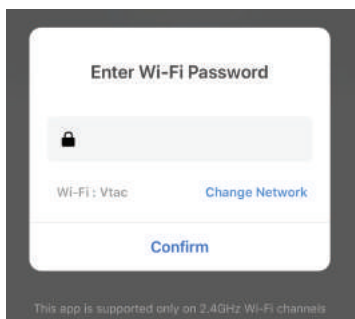

Power on the light and confirm that light blinks rapidly

[How to make light blinks rapidly](#)

Confirm light blinks rapidly

Paso 10: Una vez que haya realizado con éxito el paso 9, será redirigido a la página siguiente, donde la aplicación busca, registra e inicializa el dispositivo (lámpara) (ver imagen abajo)

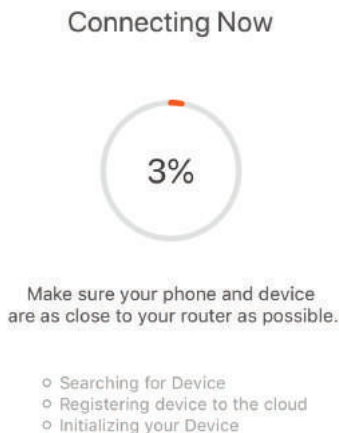

Paso 11: Una vez que el dispositivo se haya agregado correctamente, cambie el nombre del dispositivo a su preferencia.

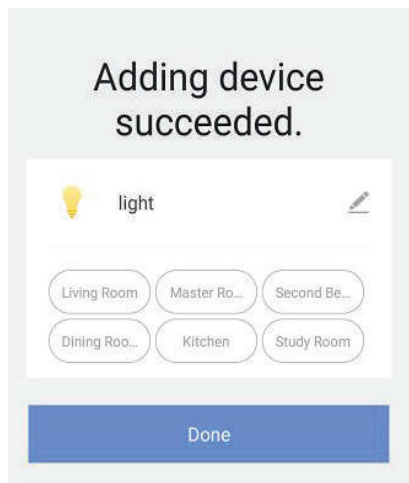

Paso 12: Después de emparejar con éxito la lámpara con la aplicación, puede comenzar a controlar múltiples funciones de la lámpara a través del móvil - el interruptor de encendido/apagado, cambiar la temperatura del color, la sincronización y los horarios, las opciones de atenuación y más.

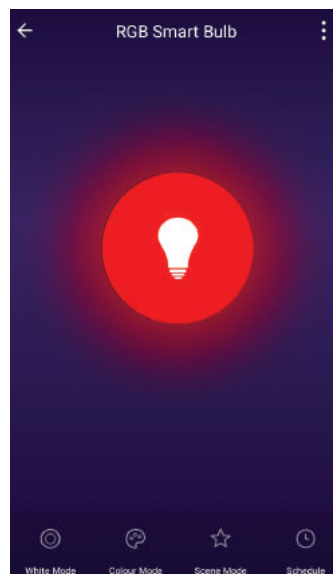
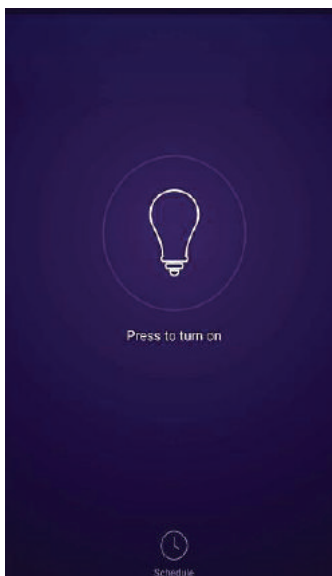
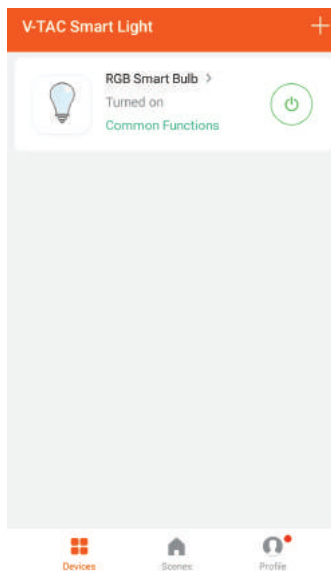

CONFIGURACIÓN DE ALEXA

Paso 1: Instale la aplicación Amazon Alexa a través de App Store (iOS) o Play Store (Android) y regístrese. Si ya tiene una cuenta existente con Amazon Alexa, proceda a iniciar sesión.

Paso 2: Una vez que se encuentra en la página de inicio de Amazon Alexa, toque en el icono inferior derecho -- donde la flecha está apuntando -- para agregar un nuevo dispositivo y habilidades.

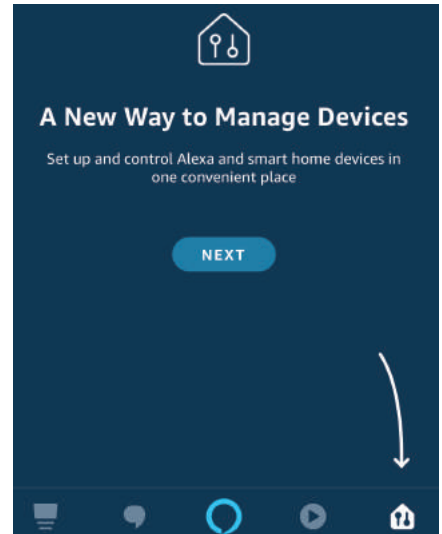

Paso 3: Pulse en Settings  y pulse en "skills and games" como se muestra a continuación.

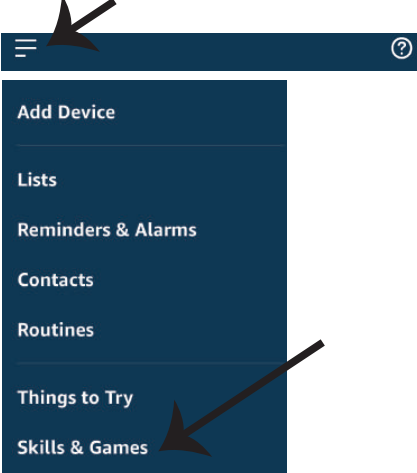

Paso 4: Busque 'V-TAC Smart Light' en la página "Skills & Games" como se muestra a continuación.

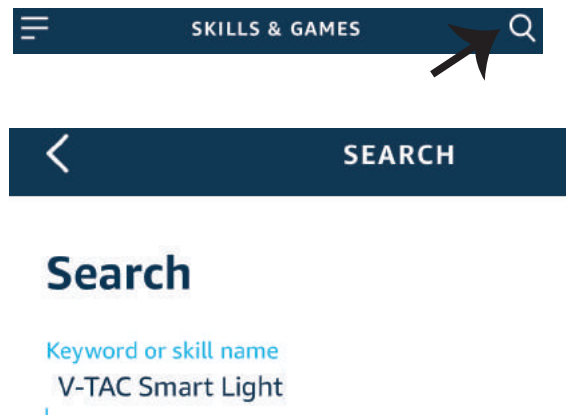

Paso 5: Habilitar el Skill.

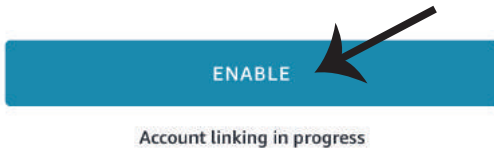

Paso 6: Ingrese su ID de inicio de sesión y su contraseña de V-TAC Smart Light y pulse "Link Now"

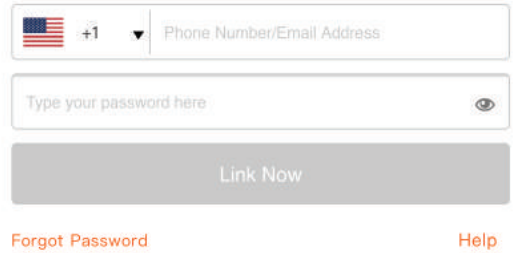

Paso 7: Una vez que pulse en Link Now, será redirigido a una nueva página solicitando autorización (ver imagen abajo). Pulse en "Authorize"



Alexa by Amazon will be able to:

- Receive your public profile
- Control your devices over internet

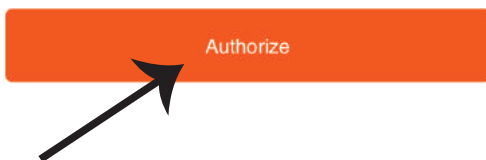

Paso 8: Recibirá la confirmación de que la cuenta que está siendo vinculada correctamente. (ver imagen abajo)

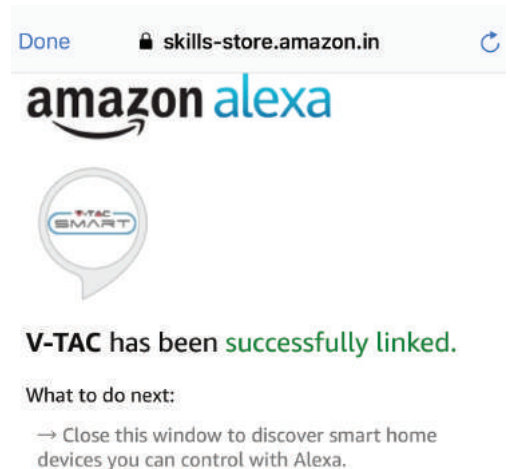

Paso 9: Descubre tu dispositivo inteligente en Alexa. Una vez que haya habilitado la habilidad.

A) Puede usar el comando de voz "Alexa discover devices" para el dispositivo Alexa que tiene.

B) Para agregar el dispositivo manualmente en la página de inicio, pulse en  y pulse en Agregar dispositivo, seleccione el dispositivo que está agregando y pulse en descubrir dispositivo.

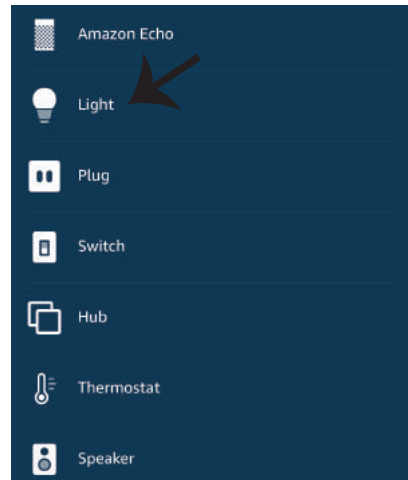
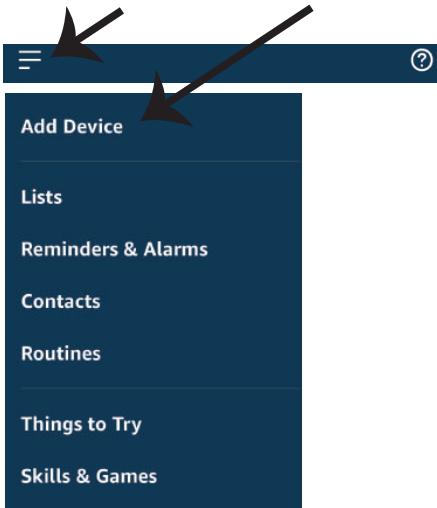

Nota: El descubrimiento del dispositivo debe hacerse cada vez que se cambia el nombre del dispositivo en la aplicación.

Comandos de ALEXA

Ahora puede controlar su dispositivo inteligente al usar comandos orales con Alexa. Siguen unos cuantos comandos que puede usar:

- ! *Alexa, turn on/off bedroom light.*
- ! *Alexa, set bedroom light to 50 percent.*
- ! *Alexa, set bedroom light to green.*
- ! *Alexa, set bedroom light to warm white.*

COSAS QUE RECORDAR ANTES DE INICIAR LA INSTALACIÓN:

1. *Aplicación V-TAC Smart Light y aplicación Amazon Alexa*
2. *Asegúrese de que tenga el dispositivo Amazon Alexa (que incluye Echo, Echo Tap, o Echo Dot)*
3. *Dispositivo inteligente*
4. *Red estable de Wifi*

INSTALACIÓN DE GOOGLE HOME

Paso 1: a y b) Instalar la aplicación Google Home por medio del Depósito de Aplicaciones (iOS) o de Play Store (Android) y registrarse. Al disponer desde ya de una cuenta con Google Home, entonces proceda a la conexión.

c) Crea un nuevo Home/escoja por entre los existentes, si los hubiera.

d) Pon ON al dispositivo Google Home y conéctelo a la aplicación. (Luego proceda al Paso 2)

a. Welcome home

Your content and devices all in one place



GET STARTED >

b. Choose account

This account will be used to personalize your experience

c. Choose a home

You will be able to control the devices and services in this home.



+ Create another home

d. Plug in your device

Make sure your device is nearby and connected to power, then try again

Paso 2: Una vez estando en la página de Google home, toque el ícono Agregar "+" para agregar un nuevo dispositivo y habilidad. Y luego toque el dispositivo de configuración como se muestra a continuación.

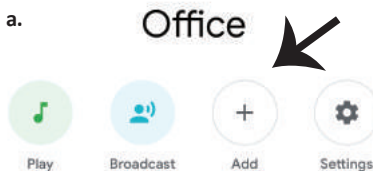

Office
1 device

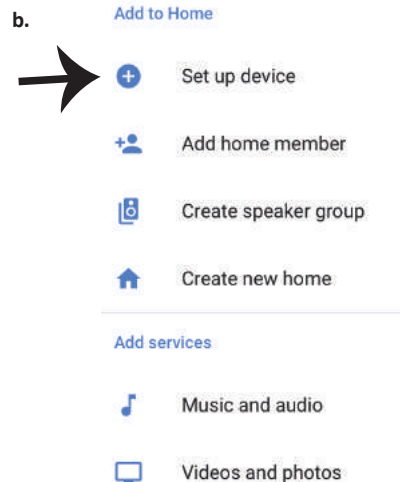
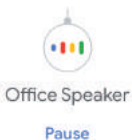

Paso 3: Asegúrese de que la bombilla inteligente está emparejada con la aplicación de luz inteligente V-TAC antes de iniciar Paso 3. Toque en la sección de flecha como se resalta en la imagen de abajo.

Set up

Set up new devices or add existing devices and services to your home



New devices

 **Set up new devices**
Google Home, smart displays and devices labelled 'Made for Google' such as C by GE smart bulbs

Works with Google

 **Have something already set up?** 
Link your smart home services such as Philips Hue and TP-Link.

Paso 5: Inicie sesión con sus credenciales de inicio de sesión de luz inteligente V-TAC para vincular el dispositivo Smart Light

 +1  Phone Number/Email Address

Type your password here 

Link Now

[Forgot Password](#)

[Help](#)

Paso 4: Escriba "V-TAC Smart Light" en la barra de búsqueda y pulse en el ícono de "V-TAC Smart Light".

 **V-TAC Smart Life** 

Paso 6: Seleccione la luz inteligente V-TAC como se muestra a continuación. y pulse en vincular ahora (Link Now).



Google will be able to:
Receive your public profile
Control your devices over internet

Authorize 

Paso 7:

- a. Ahora se vinculará su cuenta, por favor permanezca en la página en que será redirigido en pocos segundos para seleccionar el dispositivo para agregar a su Casa .
- b. Seleccione el dispositivo y pulse en Next (como se muestra en la imagen b).

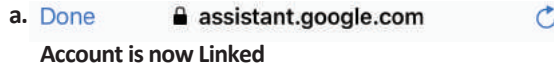

b.  Choose device

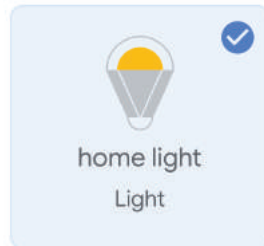
**Paso 8:**

Seleccione el Hogar (Home) en que desea agregar la luz inteligente. (O) puede crear un Nuevo hogar con el fin de añadir la luz inteligente al mismo.

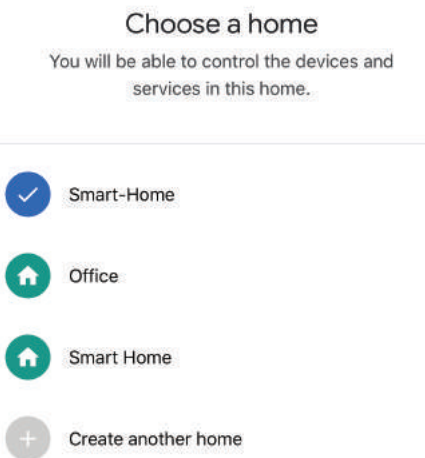

Paso 9: Has añadido correctamente el dispositivo Smart Light a tu aplicación de Google Home.

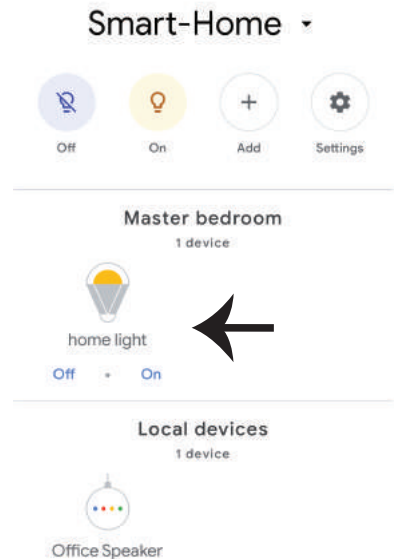

Paso 10:

- a. Puede encender/apagar la lámpara tocando en las opciones de encendido/apagado (como se muestra en la imagen a). (O) puede tocar en la lámpara inteligente.
- b. Se le redirige a la página (como se muestra en la imagen b) donde se puede controlar las luces "Power and Dimming functionality".

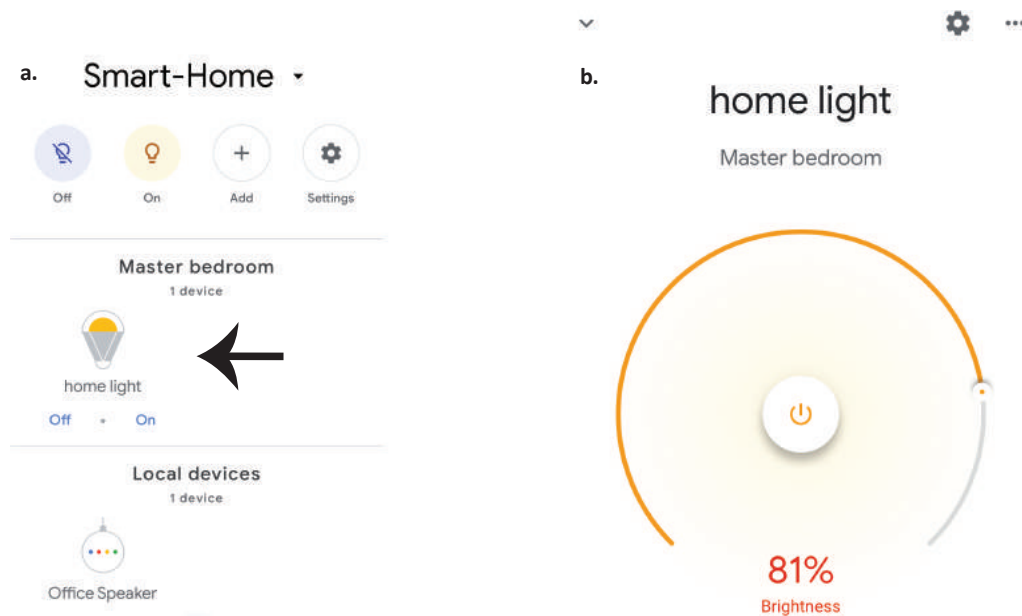
**Comandos de Google:**

Ahora, puede controlar su dispositivo inteligente mediante comandos de voz en Google Home. A continuación, se muestran algunos comandos que puede utilizar:

- ! *OK Google, turn on/off bedroom light*
- ! *OK Google, set bedroom light to 50 percent.*
- ! *OK Google, set bedroom light to green.*
- ! *OK Google, set bedroom light to warm white.*

COSAS QUE DEBE RECORDAR ANTES DE COMENZAR LA INSTALACIÓN:

1. Aplicación de luz inteligente V-TAC y aplicación de Google Home
2. Asegúrese de que tiene Google Home Device
3. Dispositivo inteligente
4. Red estable de Wifi

FELSZERELÉSI UTASÍTÁS

- 1) Kapcsolja ki a tápellátást a szerelés megkezdése előtt (lásd az ábrát, 1. rész)
- 2) Csavarja le és vegye le a fedelet (lásd az ábrát, 2. rész)
- 3) Fúrjon lyukat a mennyezetbe, hogy rögzítse a lámpát csavarokkal (lásd az ábrát, 3. rész)
- 4) Kösse a vezetékeket (lásd az ábrát, 4. rész), mielőtt rögzítené a lámpát a mennyezet csavarokkal.
- 5) Csavarja le és rögzítse a fedelet a lámpához (lásd az ábrát, 5. rész)
- 6) Kapcsolja be az áramellátást és tesztelje a lámpát.

BIZTONSÁGI FIGYELMEZTETÉS

- 1) A lámpák beltéri használatra korlátozódnak, és nem ajánlott nedves környezetben történő használatra.
- 2) A lámpákat és a lámpást nem lehet a szokásos éghető anyagok felületére felszerelni. A hőmérséklet emelkedése normális a lámpáknál.
- 3) Ne gyakoroljon külső erőt vagy ne dobja a lámpát.
- 4) A lámpákat hűvös / száraz helyen kell tárolni. Mindig győződjön meg róla, hogy a lámpa szerelése előtt a környezet tiszta.
- 5) Ne dobja ki a lámpákat a szokásos szeméttel. A lámpákat elektronikus alkatrészekkel készítik el, és azokat megfelelő helyen kell tárolni, egységes kezeléssel kell bánni például, mint a hagyományos elektronikus berendezések.

APP SZERELÉS

1. lépés: Szkenelje be az adott QR-kódot, vagy töltsse le a "V-TAC Smart Light" alkalmazást az App Store-ból (iOS) vagy a Google Play Áruházból (Android).

For ANDROID



For IOS



4. lépés: Nyissa meg a V-TAC Smart Light alkalmazást, és érintse meg a regisztrációt az új fiók létrehozásához.

V-TAC Smart Light

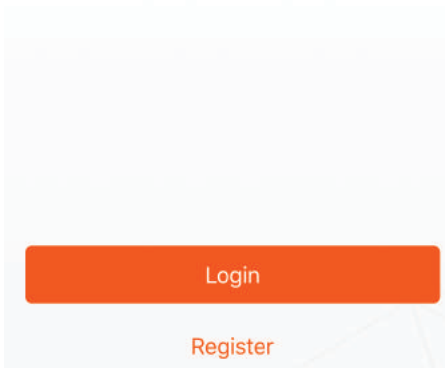

6. lépés: Adja meg a mobilszámra / e-mail azonosítójához küldött ellenőrző kódot, majd hozzon létre egy új jelszót a fiókjához, és érintse meg a „Megerősítés” gombot.

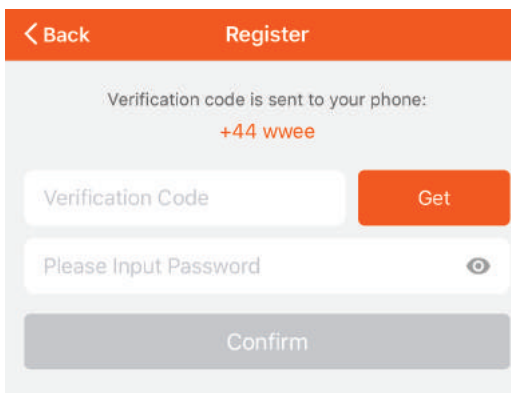

5. lépés:

A) Mobilszám: Válassza ki az országot, majd adja meg a mobilszámát. Ha elkészült, kattintson a „Tovább” gombra.

B) E-mail cím: Adja meg az e-mail azonosítóját, és érintse meg a „Tovább” gombot.

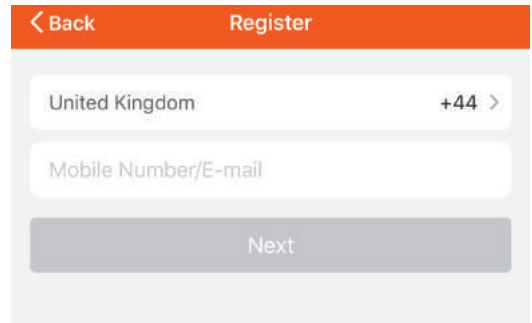

7. lépés: Érintse meg az "Eszköz hozzáadása" vagy a + jelet. Győződjön meg arról, hogy a lámpa be van kapcsolva.

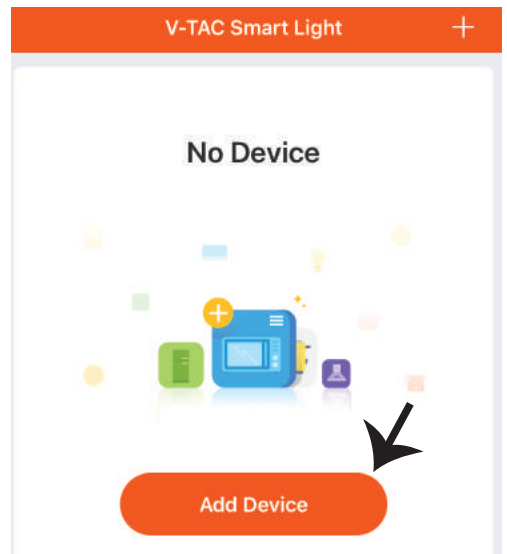

8. lépés: Válassza a "Világítóeszközök" lehetőséget a lámpa párosításához az alkalmazáshoz.

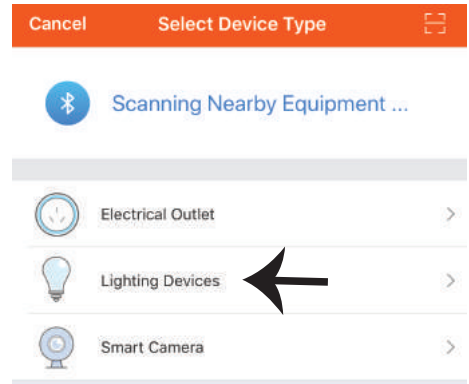

9. lépés: A készülék és a lámpa párosításához győződjön meg arról, hogy a fény gyorsan villog.

Ha a fény gyorsan villog, a lámpa párosítási módban van. Ha az izzó nem villog gyorsan, tegye az alábbiak között egyikét:

A. Kapcsolja be az izzót ismételt 3-szor, rövid időközönként kevesebb, mint 2 másodpercig.

B. Érintse meg a "Hogyan a világítás gyorsan villogna" linket (ahogy a képen látható)

Hálózati módok:

1) EZ mód: A fény másodpercenként kétszer villog

2) AP mód: Lassú villanás, 2 másodpercenként
Az "Eszköz hozzáadása" oldalon ellenőrizze, hogy az izzó EZ üzemmódban van-e. Ha nem, akkor az EZ módba kapcsolhatja, ha bekapcsolja a készüléket háromszor.

Erősítse meg, ha a fény gyorsan villog, válassza ki a WiFi hálózatot, és adja meg a jelszót.

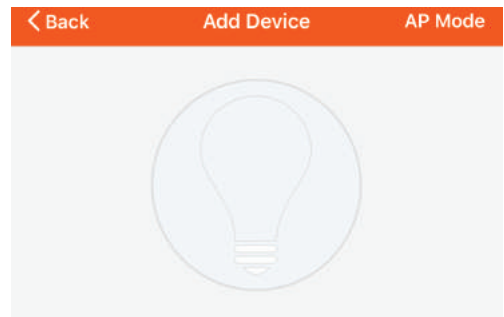
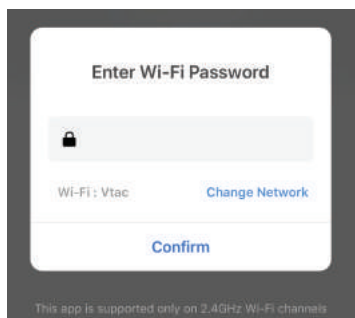

Power on the light and confirm that light blinks rapidly

[How to make light blinks rapidly](#)

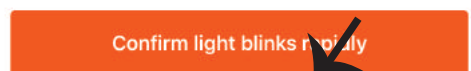

10. lépés: Miután sikeresen befejezte a 9. lépést, át lesz irányítva az alábbi oldalhoz, ahol az alkalmazás megkeresi, regisztrálja és inicializálja az eszközt (lámpát) (lásd az alábbi képet).

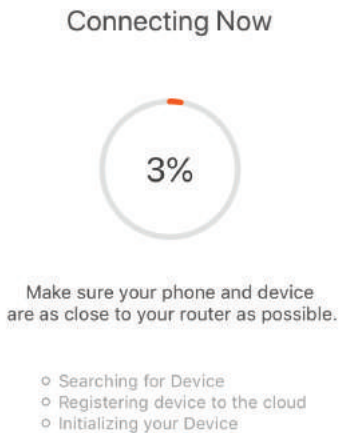

11. lépés: Ha sikeresen hozzáadta a készüléket, nevezze át a belátása szerint.

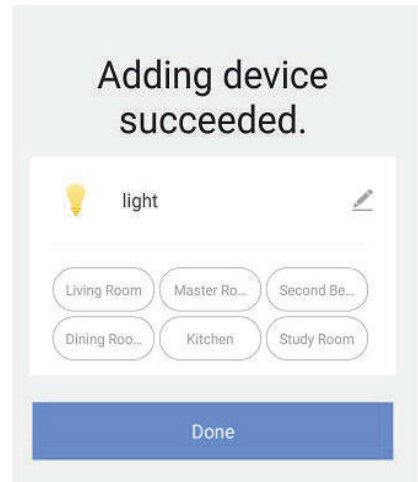

12. lépés: Miután sikeresen párosította a lámpát az alkalmazással, elkezdheti a lámpa több funkciójának vezérlését a mobil - on / off kapcsolón keresztül, megváltoztatva a színhőmérsékletet, az időzítést és az ütemezéseket, a tompítási beállításokat és így tovább.

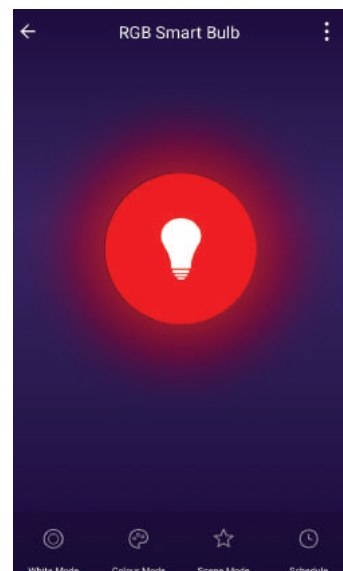
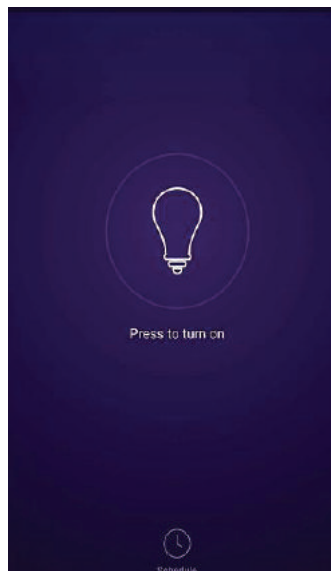
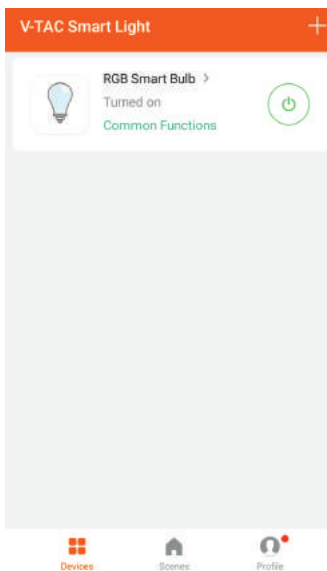

ALEXA BEÁLLÍTÁSAI

1. lépés: Telepítse az Amazon Alexa alkalmazást az App Store (iOS) vagy a Play Store (Android) segítségével és regisztrálja magát. Ha már létező fiókja van az Amazon Alexával, kérjük, lépjen a bejelentkezéshez.

2. lépés: Amint az Amazon Alexa kezdőlapján tartózkodik, érintse meg az alsó jobb oldali ikont ahol a nyíl mutat új eszköz és készség hozzáadásához.

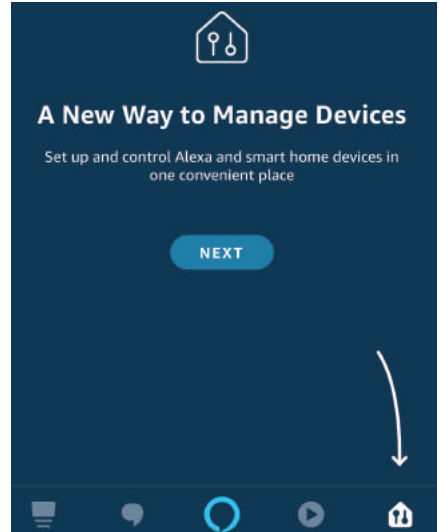

3. lépés: Érintse meg az  beállításokat, és érintse meg a „Ügyességek és játékok” pontot az alábbiak szerint.

4. lépés: Keresse meg a „V-TAC intelligens fényt” az „Ügyességek és játékok” oldalon az alábbiak szerint.

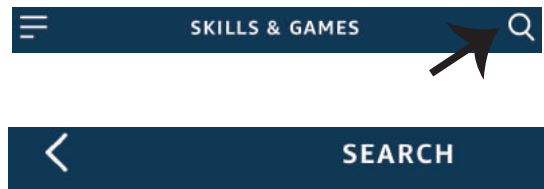
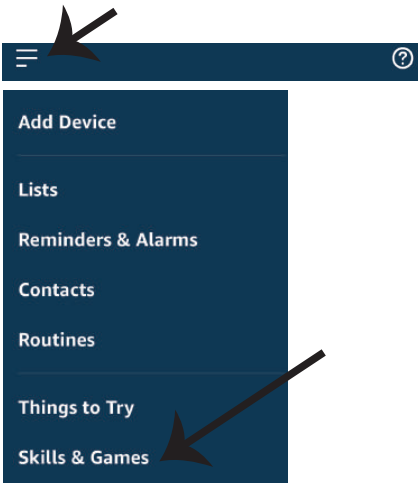

Search

Keyword or skill name
V-TAC Smart Light

5. lépés: A készség engedélyezése



6. lépés: Adja meg a V-TAC Smart Light bejelentkezési azonosítóját és jelszavát, és érintse meg a „Link most” elemet.

[Forgot Password](#)
[Help](#)

7. lépés: Miután megérintette a linket, a rendszer átirányítja az új, engedélyt kérő oldalra (lásd az alábbi képet). Érintse meg az „Engedélyezés” gombot.



Alexa by Amazon will be able to:

Receive your public profile
Control your devices over internet



8. lépés: Megerősítést fog kapni arról, hogy a fiók sikeresen csatlakozik (lásd az alábbi képet).



V-TAC has been **successfully linked**.

What to do next:

→ Close this window to discover smart home devices you can control with Alexa.

9. lépés: Fedezze fel intelligens készülékét az Alexa-on. Miután engedélyezte az ügyességet.

A) Az „Alexa discover devices” hangutasítást használhatja az Alexa eszközhöz.

B) Ha manuálisan szeretné hozzáadni az eszközt a kezdőlapon, érintse meg az  gombot, majd érintse meg az Add device (Eszköz hozzáadása) elemet, válassza ki a hozzáadni kívánt eszközt, és érintse meg a Discover device (felfedezés) eszközt.

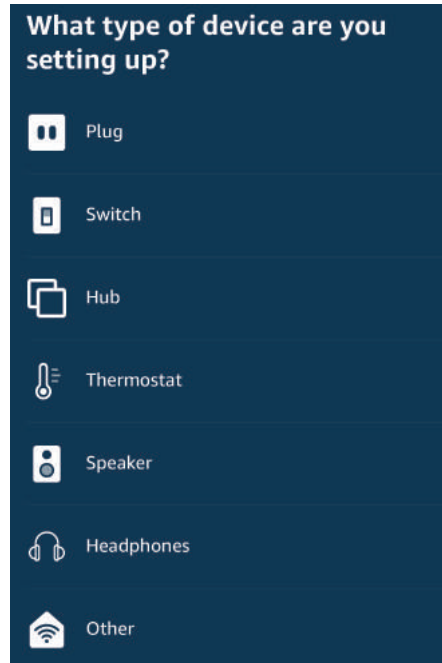
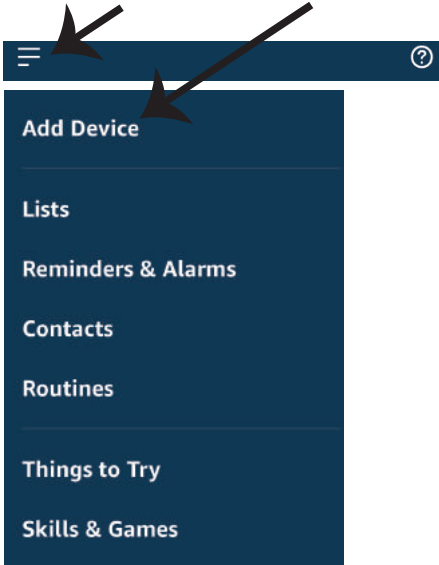

Megjegyzés: A készülék felfedezése minden alkalommal megtörténik, amikor az eszköz neve megváltozik az alkalmazásban.

ALEXA Parancsok

Most már vezérelheti intelligens készülékét az Alexa hangutasításával. Az alábbiakban néhány parancs használható:

- ! Alexa, turn on/off bedroom light.
- ! Alexa, set bedroom light to 50 percent.
- ! Alexa, set bedroom light to green.
- ! Alexa, set bedroom light to warm white.

A telepítés megkezdése előtt emlékeznie kell:

1. Mellékletek: V-TAC Smart Light App és Amazon Alexa App
2. Győződjön meg róla, hogy van Amazon Alexa eszköz (beleértve Echo, Echo Tap vagy Echo Dot)
3. Intelligens készülék - Lámpa
4. Stabil Wifi hálózat

GOOGLE HOME Beállításai

1. lépés: a & b) Telepítse az alkalmazást: Google Home az App Store (iOS) vagy a Play Store (Android) segítségével és regisztrálja magát. Ha rendelkezik már meglévő fiókjával a Google kezdőlapján, lépjen be.

c) Hozzon létre egy új otthonot / válasszon a meglévő otthonból, ha van ilyen.

d) Kapcsolja be a Google Home eszközt, és csatlakoztassa az alkalmazáshoz. (Ezután folytassa a 2. lépéssel)

a. Welcome home

Your content and devices all in one place



b. Choose account

This account will be used to personalize your experience

d. Plug in your device

Make sure your device is nearby and connected to power, then try again

c. Choose a home

You will be able to control the devices and services in this home.



Create another home

GET STARTED >

2. lépés: Ha a Google kezdőlapján tartózkodik, érintse meg a "+" ikont új eszköz és készség hozzáadásához. Ezután érintse meg a Set up device (Eszköz beállítása) elemet az alábbi képen.

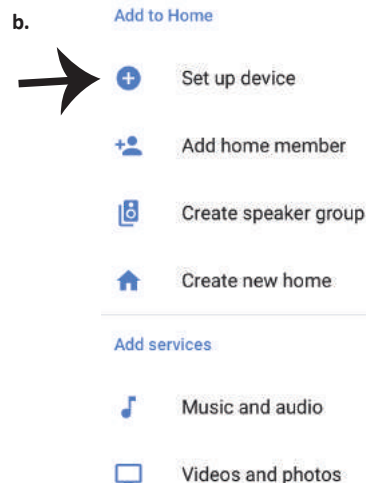
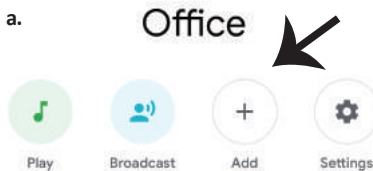

Office
1 device



Office Speaker

Pause

3. lépés: A 3. lépés megkezdése előtt győződjön meg arról, hogy a Smart Bulb párosítva van a V-TAC Smart Light alkalmazással. Érintse meg a nyílzakaszt, ahogy az az alábbi képen látható.

Set up

Set up new devices or add existing devices and services to your home

New devices



Set up new devices

Google Home, smart displays and devices labelled 'Made for Google' such as C by GE smart bulbs

Works with Google



Have something already set up?

Link your smart home services such as Philips Hue and TP-Link

5. lépés: Jelentkezzen be a V-TAC Smart Light bejelentkezési hitelesítő adataival az intelligens fény eszköz csatlakoztatásához.

+ 1 ▼

👁️

Link Now

[Forgot Password](#)

[Help](#)

4. lépés: Írja be a „V-TAC Smart Light” szót a keresősávba, és érintse meg a „V-TAC Smart Light” ikonját.



V-TAC Smart Life

6. lépés: Válassza ki a V-TAC intelligens fényt az alábbiak szerint. és érintse meg a Link most gombot.



Google will be able to:

Receive your public profile
Control your devices over internet

Authorize

7. lépés:

a. A fiókot most összekapcsolja, kérjük, maradjon az oldalon, amit néhány másodperc alatt átirányít, hogy kiválassza a készüléket, amelyet hozzáadhat az otthonához.



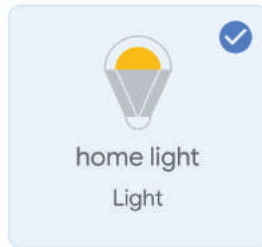
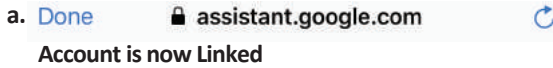

b. Jelölje ki az eszközt, és érintse meg a Next (Következő) gombot (ahogy a b) képen látható).



8. lépés: Válassza ki az Otthont, ahová az intelligens fényt kívánja hozzáadni. (Vagy) létrehozhat egy Új otthont és hozzáadni az intelligens világítást.

Choose a home

You will be able to control the devices and services in this home.

-  Smart-Home
-  Office
-  Smart Home
-  Create another home

9. lépés: Sikeresen hozzáadta a Smart Light eszközt a Google kezdő alkalmazásához.

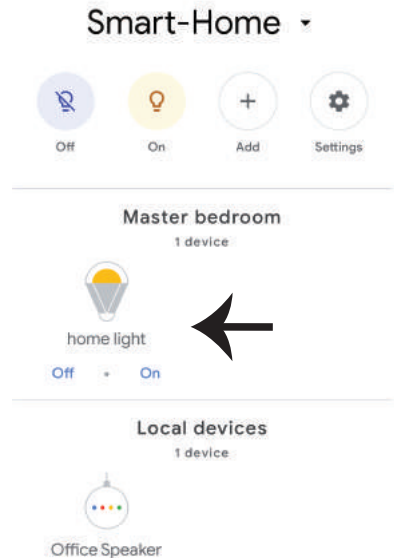

11. lépés:

a. A lámpa be / ki kapcsolása bekapcsolható a Be / Ki opció segítségével (az a) képen látható módon). (VAGY) Érintse meg az intelligens lámpát.

b. Ön átirányításra kerül az oldalra (amint a b) ábrán látható), ahol vezérelheti a "Power and Dimming" Bekapcsolás és sötétítés) funkciót.

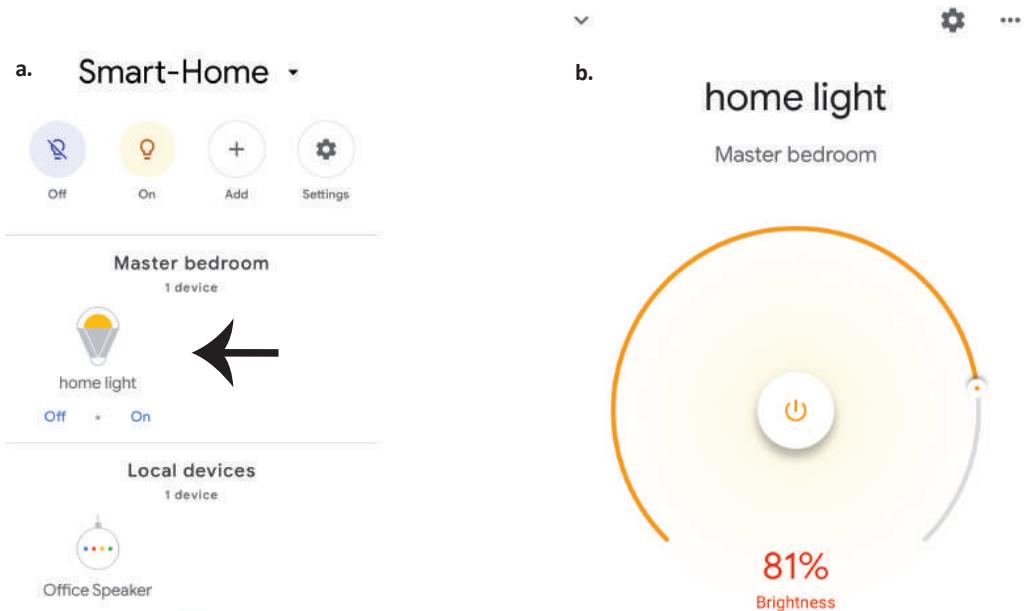
**Google Parancsai:**

Most már vezérelheti intelligens készülékét a Google Home hangutasításával. Az alábbiakban néhány parancs használható:

- ! *OK Google, turn on/off bedroom light*
- ! *OK Google, set bedroom light to 50 percent.*
- ! *OK Google, set bedroom light to green.*
- ! *OK Google, set bedroom light to warm white.*

A telepítés megkezdése előtt emlékeznie kell:

1. *Mellékletek: V-TAC Smart Light App és a Google Home App*
2. *Győződjön meg róla, hogy rendelkezik Google Home eszközzel*
3. *Intelligens készülék*
4. *Stabil Wifi hálózat*

ISTRUZIONI PER L'INSTALLAZIONE

- 1) Prima di iniziare l'installazione, scollegare l'alimentazione (vedi la figura Parte 1)
- 2) Ruotare e rimuovere il coperchio (vedi la figura Parte 2)
- 3) Eseguire un foro nel soffitto per fissare la lampada usando le viti (vedi la figura Parte 3)
- 4) Collegare i fili (vedi la figura Parte 4) prima di fissare la lampada usando le viti.
- 5) Ruotare e bloccare il coperchio alla lampada (vedi la figura Parte 5)
- 6) Collegare l'alimentazione e testare la lampada.

AVVERTENZA PER LA SICUREZZA

- 1) Le lampade sono limitate all'uso interno e non sono consigliati per l'uso in ambienti umidi.
- 2) Le lampade e le lanterne non possono essere installate sulla superficie di materiali infiammabili. L'aumento della temperatura è normale per le lampade.
- 3) Non esercitare una forza esterna o lanciare la lampada.
- 4) Le lampade devono essere conservate in un luogo fresco/asciutto. Assicurarsi sempre che l'ambiente sia pulito prima di installare la lampada.
- 5) Non smaltire le lampade con i rifiuti comuni. Le lampade sono realizzate con componenti elettronici e devono essere smaltite correttamente in luoghi designati con trattamento unificato come le apparecchiature elettroniche tradizionali.

APP INSTALLAZIONE

Passo 1: Eseguire la scansione del codice QR specificato o scaricare la "V-TAC Smart Light" dall'App Store (iOS) o dal Google Play Store (Android).

For ANDROID



For IOS



Passo 4: Aprire l'applicazione V-TAC Smart Light e fare clic su Registrazione per creare un nuovo account.

V-TAC Smart Light

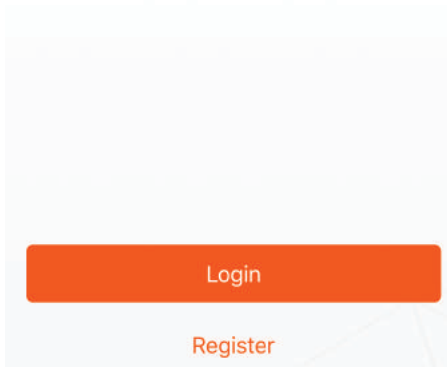

Passo 6: Inserire il codice di verifica che verrà inviato al suo telefono cellulare/e-mail, quindi assegnare una nuova password al proprio account e fare clic su "Conferma".

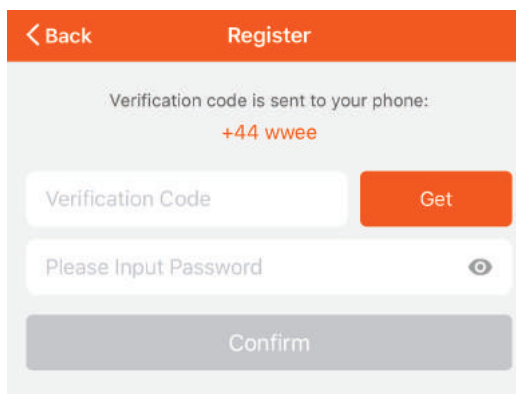

Passo 5:

A) Numero di cellulare: Selezionare il paese, quindi inserire il proprio numero di cellulare. Al termine fare clic su "Avanti".

B) E-Mail: Inserire il proprio indirizzo e-mail e fare clic su "Avanti".

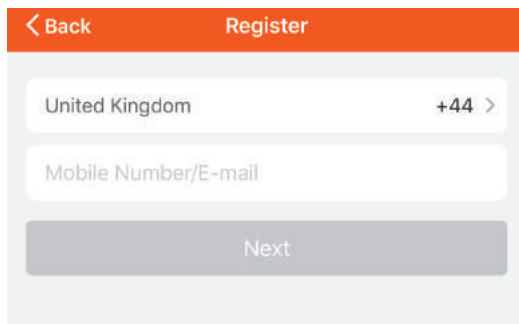

Passo 7: Fare clic su "Aggiungi dispositivo" o sul simbolo "+". Assicurarsi che la lampada sia accesa.

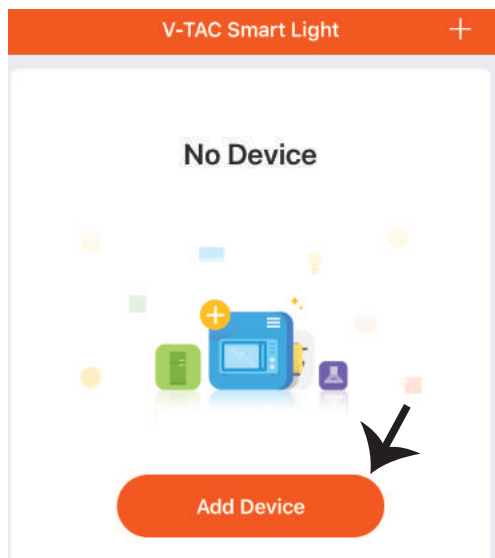

Passo 8: Selezionare "Dispositivi di illuminazione" per iniziare a collegare la lampada all'applicazione.

Passo 9: Per collegare il dispositivo alla lampada, assicurarsi che la luce lampeggi rapidamente.

Passo 9: Quando la spia lampeggia rapidamente, la lampada è in modalità di connessione. Se la spia non lampeggia rapidamente si possono eseguire una delle seguenti operazioni:

A. Accendere e spegnere la lampadina ripetutamente 3 volte ad intervalli brevi inferiori a 2 secondi.

B. Fare clic su "Come fare lampeggiare rapidamente la luce" (come mostrato nella figura).

Modalità di rete:

1) Modalità EZ: la luce lampeggia due volte al secondo.

2) Modalità AP: flash lento, una volta ogni 2 secondi.

Nella pagina "Aggiungi dispositivo", confermare se la lampadina è in modalità EZ. In caso contrario, è possibile passare alla modalità EZ attivando il dispositivo tre volte.

Confermare se la luce lampeggia rapidamente, selezionare la rete senza fili e inserire la password.

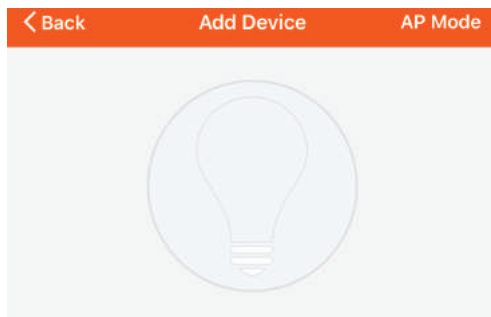
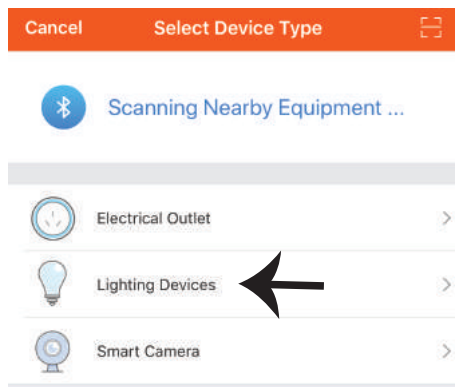
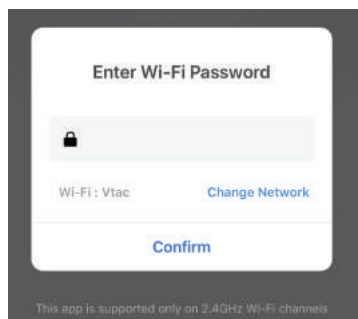

Power on the light and confirm that light blinks rapidly

[How to make light blinks rapidly](#)



Passo 10: Una volta completato con successo il passo 9, verrà reindirizzato alla pagina in basso, dove l'applicazione cerca, registra e inizializza il dispositivo (spia) (vedi la figura di riferimento cui si

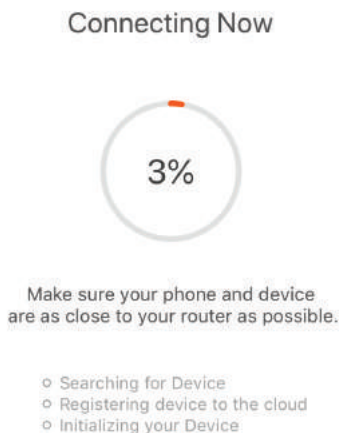

Passo 11: Una volta aggiunto il dispositivo, rinomina il dispositivo come preferisce.

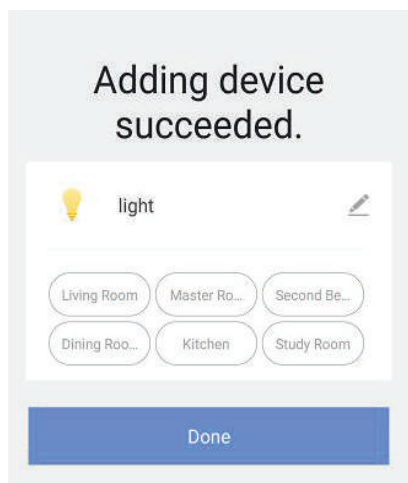

Passo 12: Dopo aver collegato la lampada all'applicazione è possibile gestire una varietà di funzioni della lampada tramite il proprio telefono cellulare – l'attivazione/la disattivazione, la temperatura del colore, la sincronizzazione e gli orari, le opzioni di regolazione della luminosità e molto altro.

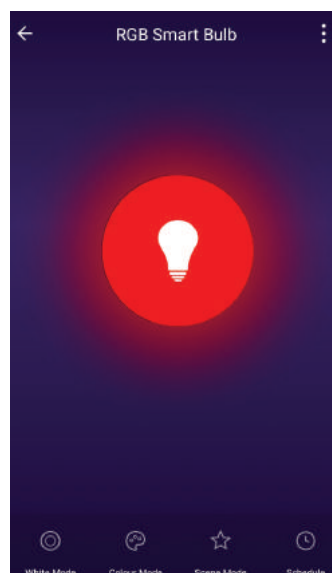
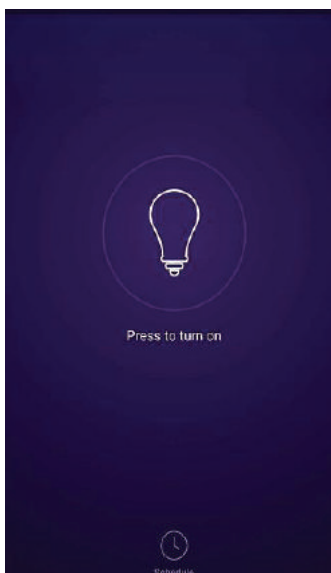
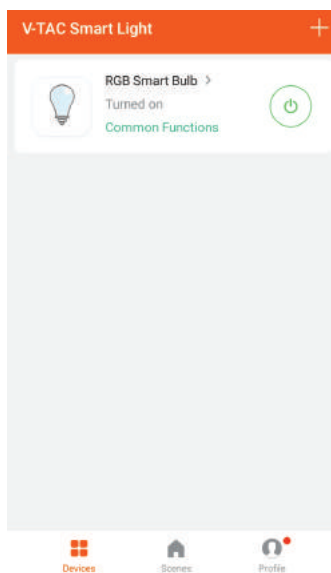

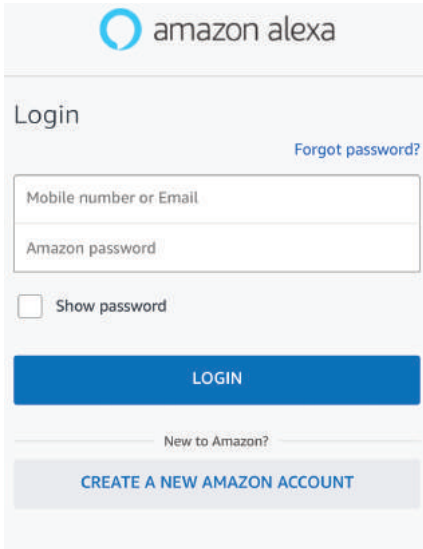

IMPOSTAZIONI DI ALEXA

Passo 1: Installa l'applicazione "Amazon Alexa" tramite l'App Store (iOS) o il Play Store (Android) e registrati. Se ha già un account Amazon Alexa, procedere con il login.

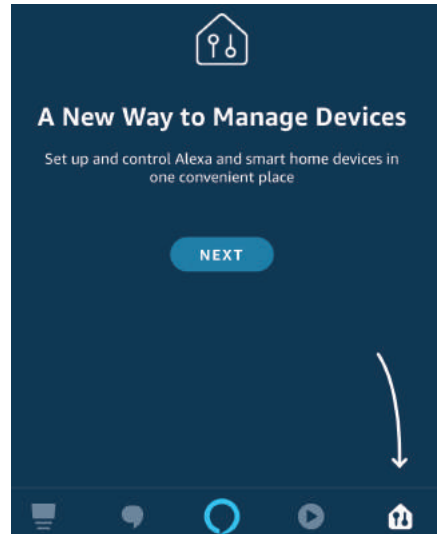

Passo 2: Una volta che si trova sulla home page di "Amazon Alexa", fare clic sull'icona in basso a destra — dove è puntata la freccia — per aggiungere un nuovo dispositivo e abilità.



Passo 3: Fare clic su  impostazioni e poi fare clic su "abilità e giochi" come mostrato di seguito.

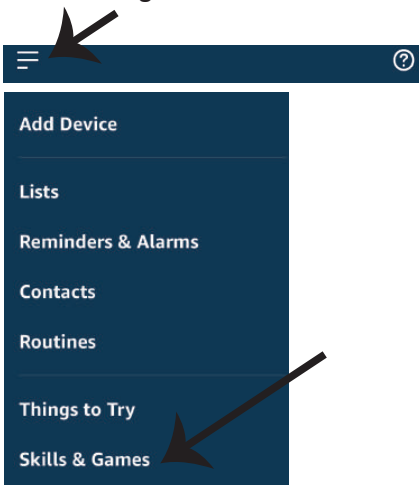

Passo 4: Cercare "V-TAC Smart Light" nella pagina "Abilità e giochi" come mostrato di seguito.

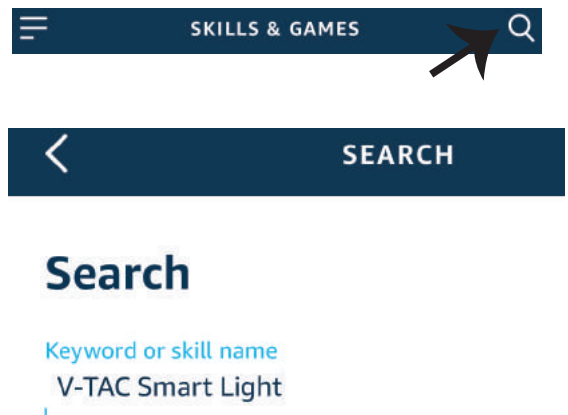

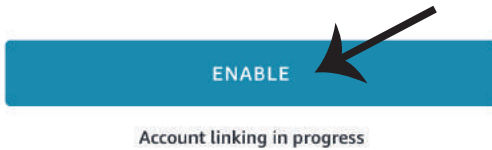
Passo 5: Consentire l'abilità.**Passo 6: Inserire l'ID di accesso e la password di V-TAC Smart Light e fare clic su "Collega ora".**

 A form with three main sections. The top section contains a dropdown menu with a US flag and "+1" next to it, followed by a text input field labeled "Phone Number/Email Address". The middle section is a password input field labeled "Type your password here" with an eye icon on the right. The bottom section is a grey button labeled "Link Now".
[Forgot Password](#)[Help](#)

Passo 7: Dopo aver fatto clic su Collega ora, verrà reindirizzato a una nuova pagina che richiede l'autorizzazione (vedi la figura di riferimento cui sotto). Fare clic su "Autorizza".



Alexa by Amazon will be able to:

Receive your public profile
Control your devices over internet



Passo 8: Riceverà la conferma che l'account è stato collegato correttamente (vedi la figura di riferimento cui sotto)

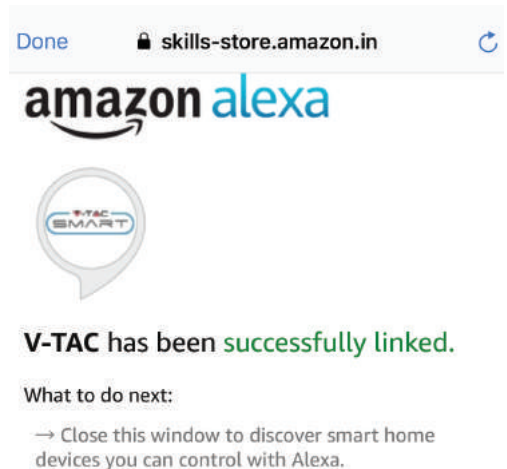

Passo 9: Trovare il proprio dispositivo intelligente su Alexa. Una volta ottenuta l'abilitazione
A) Può usare il comando vocale "Alexa trova il dispositivo" sul proprio dispositivo Alexa.

B) Per aggiungere il dispositivo manualmente, nella pagina iniziale fare clic su  e poi su Aggiungere dispositivo, selezionare il dispositivo che si desidera aggiungere e fare clic su Trovare dispositivo.

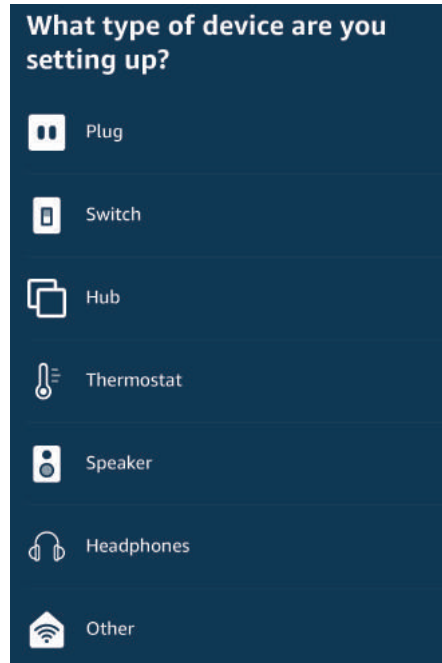
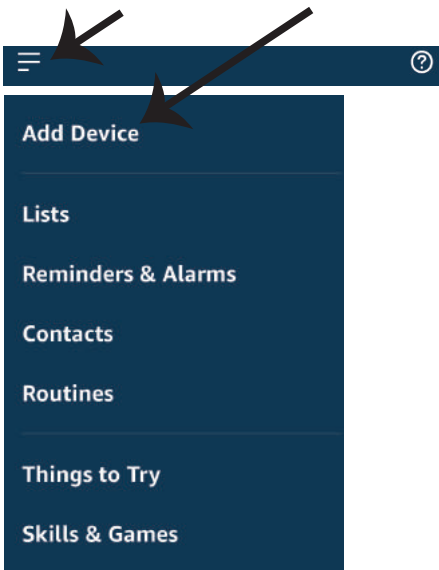

Nota: La ricerca del dispositivo deve essere eseguita ogni volta che il nome del dispositivo viene modificato nell'applicazione.

Comandi di ALEXA

Ora puoi controllare il proprio dispositivo intelligente usando i comandi vocali di Alexa. Di seguito sono riportati alcuni comandi che è possibile utilizzare:

- ! *Alexa, turn on/off bedroom light.*
- ! *Alexa, set bedroom light to 50 percent.*
- ! *Alexa, set bedroom light to green.*
- ! *Alexa, set bedroom light to warm white.*

COSE DA RICORDARE PRIMA DI INIZIARE L'INSTALLAZIONE:

1. *L'applicazione "V-TAC Smart Light" e l'applicazione "Amazon Alexa".*
2. *Assicurarsi di avere un dispositivo "Amazon Alexa" (incluso Eco, Echo Tap o Echo Dot).*
3. *Un dispositivo intelligente*
4. *Una rete senza fili stabile.*

IMPOSTAZIONI DI GOOGLE HOME

Passo 1:

- a&b) Installa l'applicazione "Google Home" tramite l'App Store (iOS) o il Play Store (Android) e registrarsi. Se ha già un account "Google Home", procedi con il login.
 c) Creare una "Nuova casa"/Scegliere dalle case esistenti, se presenti.
 d) Attivare il dispositivo "Google Home" e collegalo all'applicazione. (Quindi procedere al passo 2).

a. Welcome home

Your content and devices all in one place



b. Choose account

This account will be used to personalize your experience

d. Plug in your device

Make sure your device is nearby and connected to power, then try again

c. Choose a home

You will be able to control the devices and services in this home.



+ Create another home

GET STARTED >

Passo 2: Una volta visualizzata la pagina Home di Google, fare clic sull'icona Aggiungi "+" per aggiungere un nuovo dispositivo e abilità. Quindi, fare clic su "Impostazioni dispositivo" come mostrato nella figura sottostante.

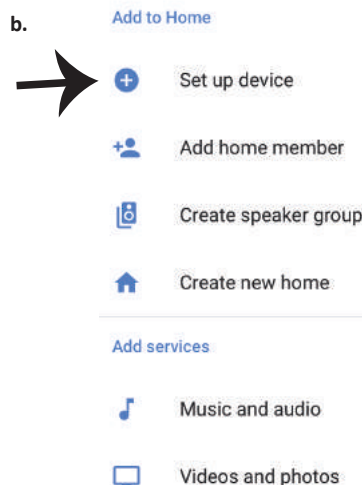
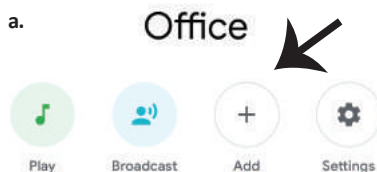

Office
1 device



Office Speaker

Pause

Passo 3: Assicurarsi che la lampadina intelligente sia collegata all'applicazione "V-TAC Smart Light", prima di iniziare il passo 3. Fare clic sulla punta della freccia come evidenziato nella figura sottostante.

Set up

Set up new devices or add existing devices and services to your home

New devices

 **Set up new devices**
Google Home, smart displays and devices labelled 'Made for Google' such as C by GE smart bulbs

Works with Google



 **Have something already set up?** 
Link your smart home services such as Philips Hue and TP-Link

Passo 5: Accedere con i propri credenziali di accesso "V-TAC Smart Light" per collegare il dispositivo "Illuminazione intelligente".

Passo 4: Digitare "V-TAC Smart Light" sulla barra di ricerca e fare clic sull'icona di "V-TAC Smart Light".

 V-TAC Smart Life 

Passo 6: Selezionare "V-TAC Smart Light" come mostrato di seguito e fare clic su "Collega adesso".

 +1  Phone Number/Email Address

Type your password here 

Link Now

[Forgot Password](#)

[Help](#)



Google will be able to:
Receive your public profile
Control your devices over internet

Authorize 

Passo 7:

a. L'account verrà collegato, rimanere sulla pagina e in pochi secondi verrà reindirizzato per selezionare il dispositivo da aggiungere alla propria casa.

b. Selezionare il dispositivo e premere “Avanti” (come mostrato nella figura b).

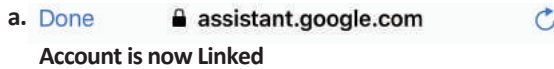



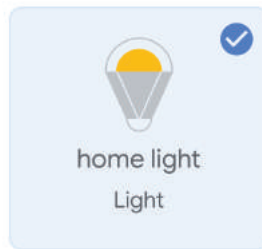

b.  Choose device



Passo 8: Selezionare la “Casa” in cui desideri aggiungere l’illuminazione intelligente (OPPURE) è possibile creare una “Nuova casa” per aggiungere l’illuminazione intelligente ad essa.

Choose a home

You will be able to control the devices and services in this home.

-  Smart-Home
-  Office
-  Smart Home
-  Create another home

Passo 9: Ha aggiunto con successo il dispositivo “Illuminazione intelligente” alla sua applicazione “Google Home”.

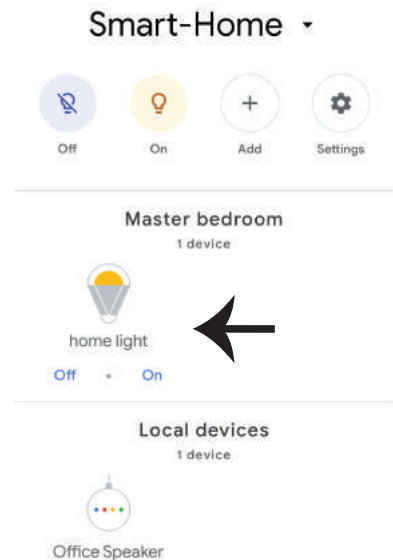

Passo 11:

- a. È possibile accendere/spegnere la lampada facendo clic sulle opzioni Acceso/Spento (come mostrato nella figura a). (OPPURE) È possibile fare clic sulla lampada intelligente.
- b. Verrà reindirizzato alla pagina (come mostrato nella figura b) dove può controllare l'illuminazione con "Funzionalità di accensione ed oscuramento".

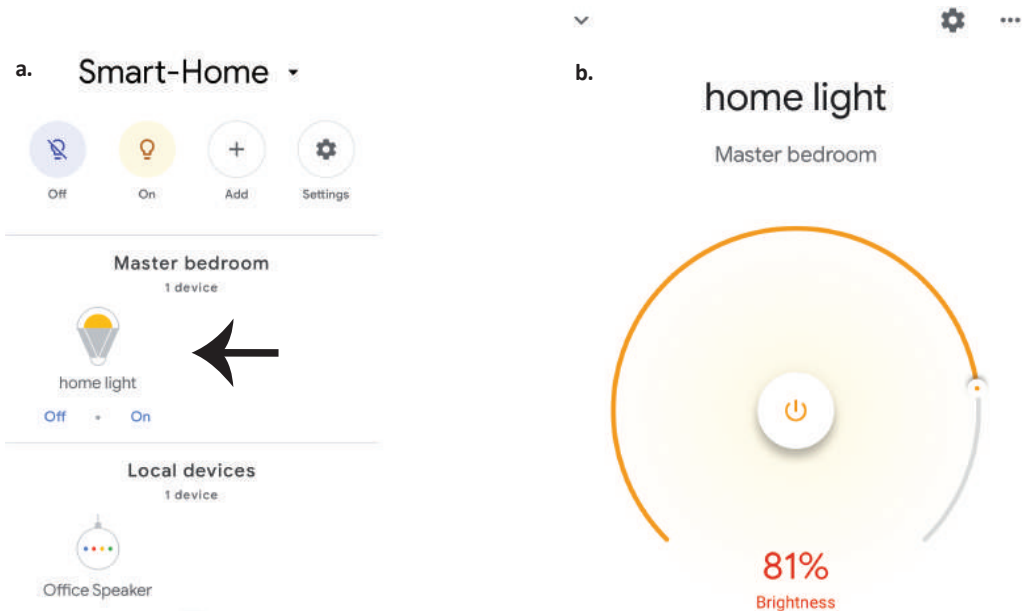
**Comandi di Google:**

Ora puoi controllare il proprio dispositivo intelligente usando i comandi vocali di Google Home. Di seguito sono riportati alcuni comandi che è possibile utilizzare:

- ! *OK Google, turn on/off bedroom light*
- ! *OK Google, set bedroom light to 50 percent.*
- ! *OK Google, set bedroom light to green.*
- ! *OK Google, set bedroom light to warm white.*

COSE DA RICORDARE PRIMA DI INIZIARE L'INSTALLAZIONE:

1. L'applicazione "V-TAC Smart Light" e l'applicazione "Google Home".
2. Assicurarsi di avere un dispositivo "Google Home".
3. Un dispositivo intelligente.
4. Una rete senza fili stabile.

ΟΔΗΓΙΕΣ ΓΙΑ ΤΗΝ ΤΟΠΟΘΕΤΗΣΗ

- 1) Προτού αρχίσετε την τοποθέτηση, διακόψτε την ηλεκτροδότηση (δες την Απεικόνιση, Μέρος 1).
- 2) Завъртете и свалете капака (δες την Απεικόνιση, Μέρος 2).
- 3) Διατρυπήστε ένα άνοιγμα στην οροφή, για να στηρίξετε τη λάμπα με τη βοήθεια των βιδών (δες την Απεικόνιση, Μέρος 3).
- 4) Συνδέστε τους αγωγούς (δες την Απεικόνιση, Μέρος 4), προτού στηρίξετε τη λάμπα στην οροφή με τις βίδες.
- 5) Γυρίστε και μπλοκάρτε το καπάκι προς τη λάμπα (δες την Απεικόνιση, Μέρος 5)
- 6) Ανοίξτε την ηλεκτροδότηση και ελέγξτε τη λάμπα.

ΠΡΟΕΙΔΟΠΟΙΗΣΕΙΣ ΓΙΑ ΤΗΝ ΑΣΦΑΛΕΙΑ ΣΑΣ

- 1) Οι λάμπες μπορούν να χρησιμοποιηθούν μόνο σε κλειστούς χώρους και δεν σας συμβουλεύουμε να τις τοποθετείτε σε χώρο με υγρασία.
- 2) Οι λάμπες και τα φανάρια δεν μπορούν να τοποθετηθούν στην επιφάνεια των κοινών εύφλεκτων υλικών. Η άνοδος της θερμοκρασίας είναι ένα σύνηθες φαινόμενο για τις λάμπες.
- 3) Μην ασκείτε εξωτερική δύναμη και μην πετάτε τη λάμπα.
- 4) Οι λάμπες πρέπει να διατηρούνται σε δροσερό/ στεγνό χώρο. Πρέπει πάντα να βεβαιωθείτε ότι το περιβάλλον είναι καθαρό, προτού τοποθετήσετε τη λάμπα.
- 5) Μην πετάτε τις λάμπες μαζί με τα κοινά απόβλητα. Οι λάμπες περιέχουν ηλεκτρονικά εξαρτήματα και πρέπει να αποβάλλονται δεόντως στα μέρη τα οποία προορίζονται για τον παραδοσιακό ηλεκτρονικό εξοπλισμό.

APP ΤΟΠΟΘΕΤΗΣΗ

Βήμα 1: Πρέπει να σκανάρετε τον QR κωδικό, ή εξάγετε το «V-TAC Smart Light» από το App Store (iOS) ή το „Google Play Store” (Android).

For ANDROID



For IOS



Βήμα 4: Ανοίξτε το Παράρτημα της V-TAC, το Smart Light και πατήστε Register (καταχώρηση), για να δημιουργήσετε νέο account.

V-TAC Smart Light

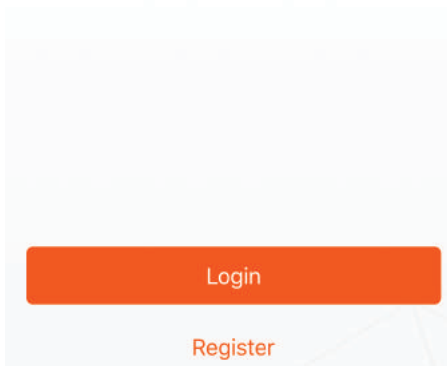

Βήμα 6: Εισάγετε τον κωδικό επαλήθευσης που θα αποσταλεί στο κινητό σας τηλέφωνο / το ηλεκτρονικό σας ταχυδρομείο, και στη συνέχεια βάλτε νέα παρόλα στο account σας και πατήστε "Confirm".

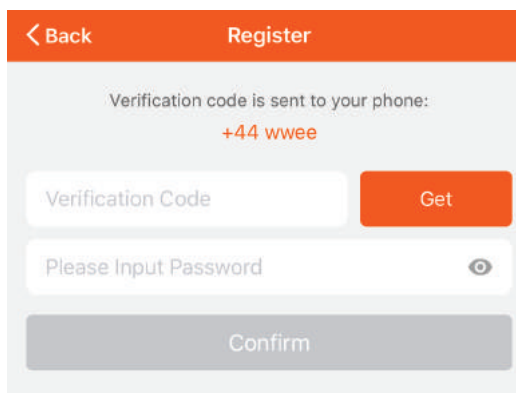

Βήμα 5:

A) Κινητό τηλέφωνο: Επιλέξτε τον κωδικό της χώρας και εισάγετε τον αριθμό του κινητού τηλεφώνου. Μετά πατήστε 'Next'.

B) Ηλεκτρονικό ταχυδρομείο: Εισάγετε την διεύθυνση του ηλεκτρονικού ταχυδρομείου και πατήστε 'Next'.

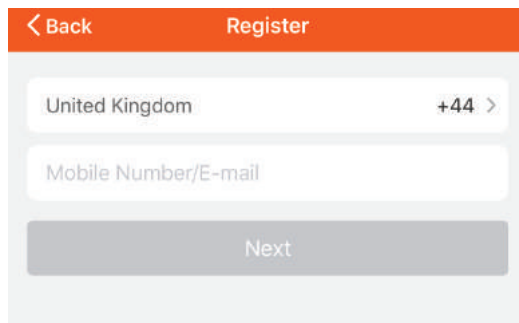

Βήμα 7: Πατήστε «Πρόσθεση συσκευής», ή το σύμβολο +. Βεβαιωθείτε ότι η λάμπα είναι αναμμένη.

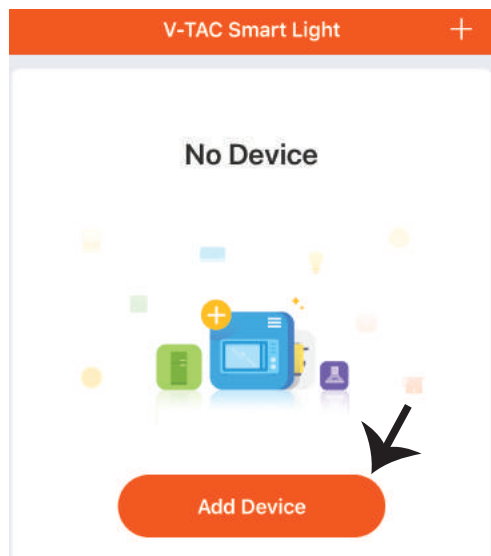

Βήμα 8: Επιλέξτε «Συσκευές φωτισμού» για να αρχίσετε τη σύνδεση της λάμπας με την εφαρμογή.

Βήμα 9: Για να συνδέσετε τη συσκευή με τη λάμπα, βεβαιωθείτε ότι το φως αναβοσβήνει γρήγορα.

Αφού η λάμπα αρχίσει και αναβοσβήνει γρήγορα, αυτή βρίσκεται σε καθεστώς σύνδεσης. Αν η λάμπα δεν αναβοσβήνει γρήγορα, μπορείτε να προβείτε σε ένα από τα εξής βήματα:

- A. Ανάψτε και σβήστε τη λάμπα 3 φορές σε μικρά διαστήματα – μικρότερα από 2 δευτερόλεπτα.
- B. Πατήστε τη σύνδεση «Πώς να κάνουμε το φωτισμό να αναβοσβήνει γρήγορα» (όπως δείχνουμε στην απεικόνιση).

Ρυθμίσεις του δικτύου:

- 1) EZ ρύθμιση: Το φως αναβοσβήνει δύο φορές το δευτερόλεπτο.
- 2) AP ρύθμιση: Αναβοσβήνει αργά, μια φορά ανά 2 δευτερόλεπτα.

Στη σελίδα «Πρόσθεση συσκευής», επιβεβαιώστε αν η λάμπα έχει ρυθμιστεί στο EZ. Σε περίπτωση που δεν έχει ρυθμιστεί έτσι, μπορείτε να τη ρυθμίσετε στην EZ, ανάβοντας τρεις φορές τη συσκευή.

Βεβαιωθείτε αν το φως αναβοσβήνει γρήγορα, επιλέξτε το δίκτυο Wi-Fi και εισάγετε την παρόλα.

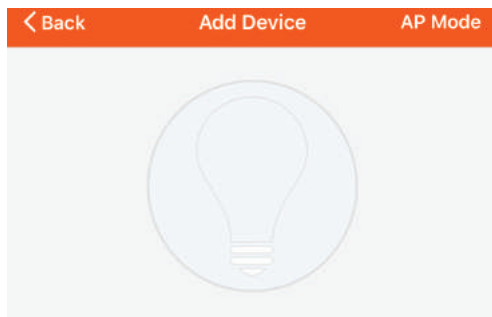
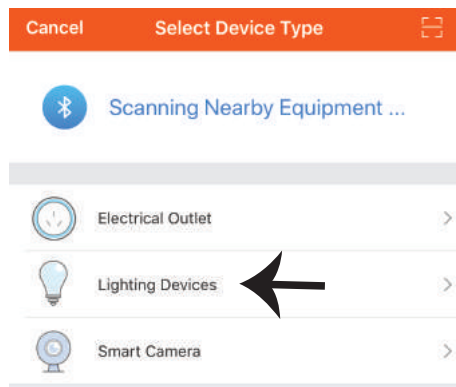
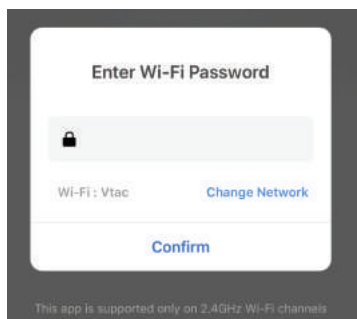

Power on the light and confirm that light blinks rapidly

[How to make light blinks rapidly](#)



Βήμα 10: Αφού ολοκληρώσετε με επιτυχία το βήμα 9, θα σας κατευθύνουν προς την κάτω σελίδα, όπου το παράρτημα αναζητεί, καταχωρεί και κινητοποιεί τη συσκευή (τη λάμπα) (βλ. το σχεδιάγραμμα πιο κάτω).

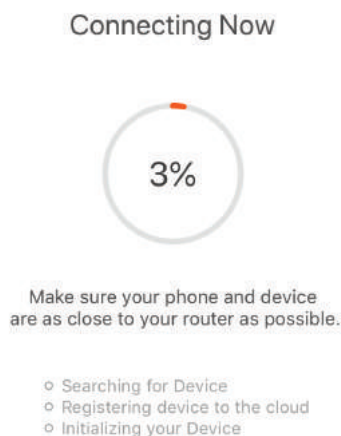

Βήμα 11: Αφού η συσκευή σας προστέθηκε με επιτυχία, μπορείτε να μετονομάσετε τη συσκευή με την αρέσκειά σας.

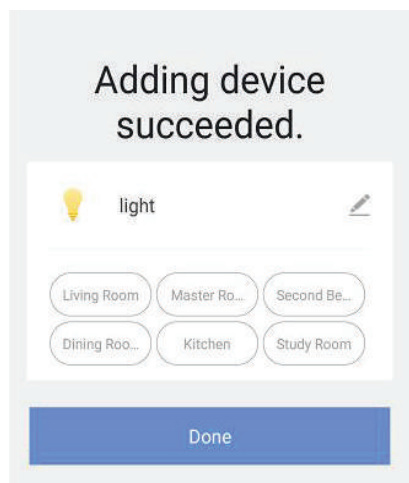

Βήμα 12: Αφού συνδέσετε με επιτυχία τη λάμπα με το Παράρτημα, μπορείτε ήδη να διαχειρίζεστε μια σειρά ιδιοτήτων της λάμπας μέσω του κινητού σας τηλεφώνου – ON/OFF, αλλαγή της θερμοκρασίας των χρωμάτων, συγχρονισμού και χρονογραφημάτων, δυνατότητες για dimming και πολλά άλλα.

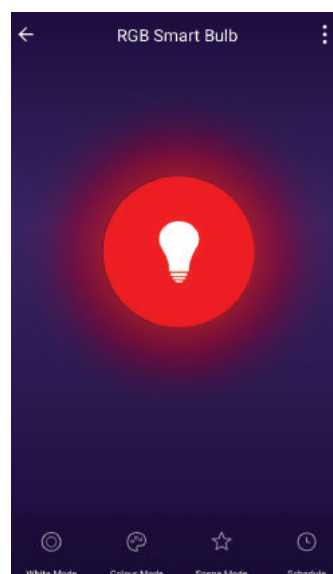
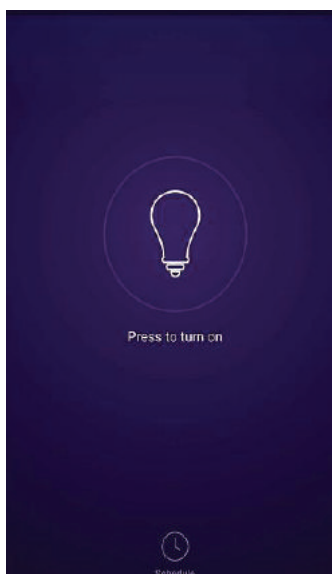
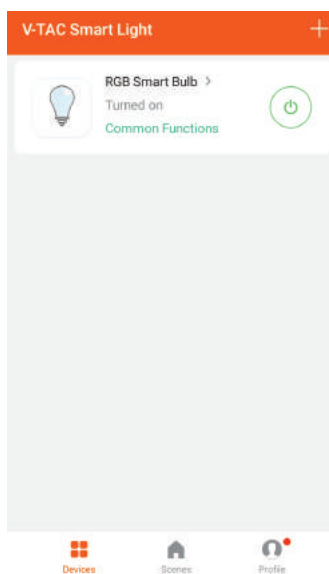

ΡΥΘΜΙΣΕΙΣ ΤΗΣ ALEXA

Βήμα 1: Τοποθετήστε την εφαρμογή "Amazon Alexa" μέσω του App Store (iOS) ή του Play Store (Android) και εγγραφείτε. Αν είχατε από πριν ένα προφίλ με Amazon Alexa, παρακαλώ μπειτε σε αυτό.

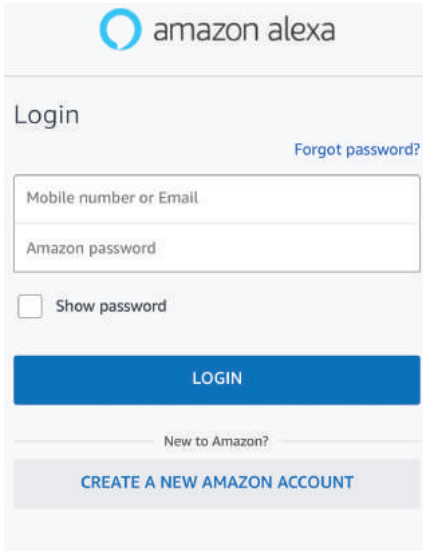

Βήμα 2: Αφού βρίσκεστε στην αρχική σελίδα της Amazon Alexa, πατήστε την κάτω δεξιά απεικόνιση – προς τα εκεί όπου δείχνει ο δείκτης – για την πρόσθεση νέας συσκευής και ικανότητας.

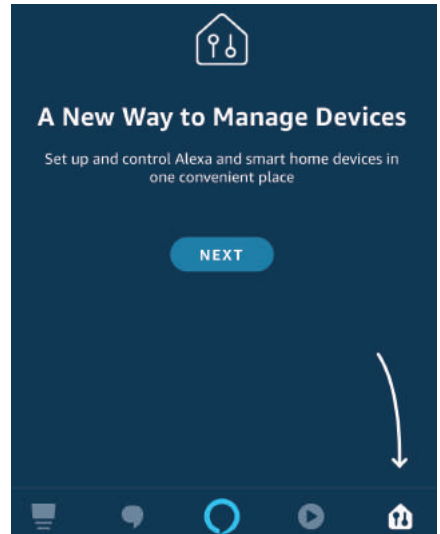

Βήμα 3: Πατήστε  Settings (ρυθμίσεις) και πατήστε "Skills & games", όπως απεικονίζεται παρακάτω.

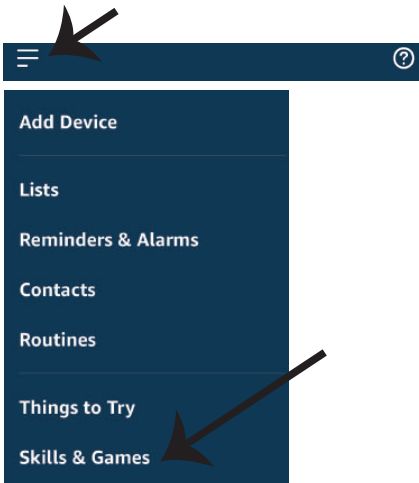

Βήμα 4: Αναζητήστε 'V-TAC Smart Light' στη σελίδα "Skills & Games", όπως απεικονίζεται παρακάτω.

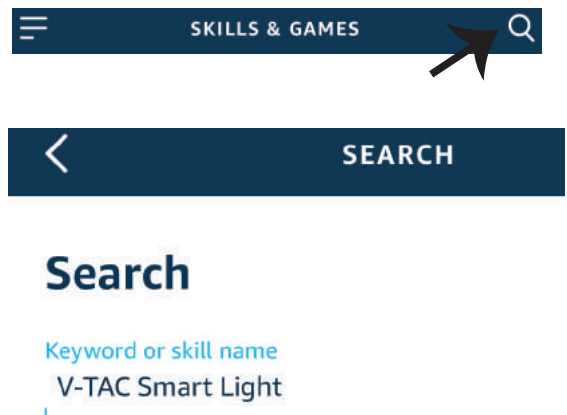

Βήμα 5: Επιτρέψτε τη χρήση της ικανότητας αυτής.

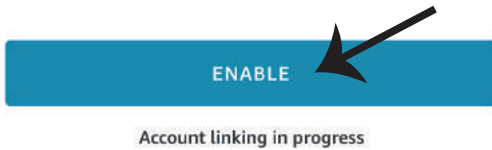

Βήμα 6: Εισάγετε το όνομα χρήστη και την παρόλα εισόδου στη V-TAC Smart Light και πατήστε “Link Now”.

[Forgot Password](#)

[Help](#)

Βήμα 7: Αφού πατήσετε Link Now, θα σας κατευθύνουν προς μια άλλη σελίδα, που απαιτεί επιβεβαίωση της ταυτότητας (βλ. το σχεδιάγραμμα παρακάτω). Πατήστε “Authorize”.



Alexa by Amazon will be able to:

- Receive your public profile
- Control your devices over internet



Βήμα 8: Θα λάβετε επιβεβαίωση για την επιτυχή σύνδεση του account (βλ. το σχεδιάγραμμα παρακάτω).



amazon alexa



V-TAC has been successfully linked.

What to do next:

- Close this window to discover smart home devices you can control with Alexa.

Βήμα 9: Ανακαλύψτε τη δική σας smart συσκευή της Alexa. Αφού αποφασίσετε και κάνετε την επιλογή σας,

A) Μπορείτε να δώσετε τη φωνητική εντολή "Alexa discover devices" στη δική σας συσκευή Alexa.

B) Για να προσθέσετε μια συσκευή με το χέρι, πατήστε στην αρχική σελίδα το  και στη συνέχεια Add device, επιλέξτε τη συσκευή που θέλετε να προσθέσετε, και πατήστε Discover device.

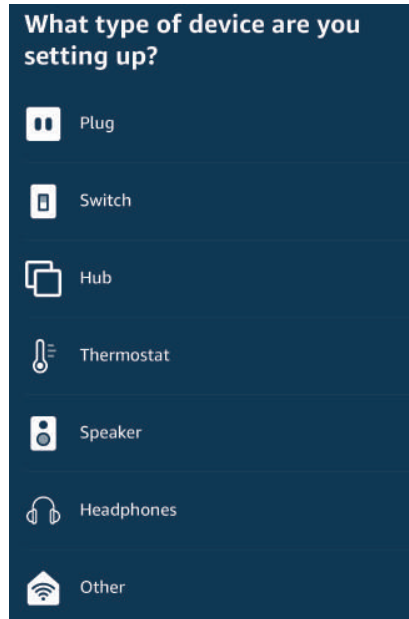
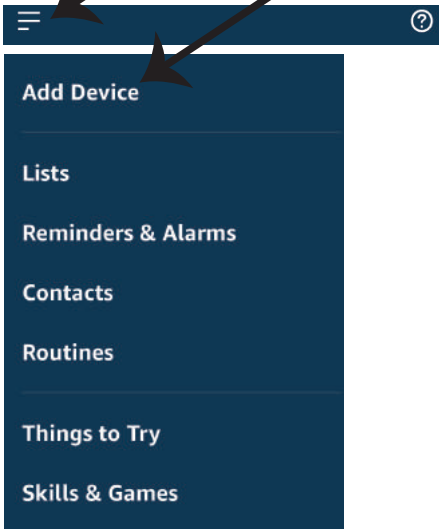

Σημείωση: Η ανακάλυψη της συσκευής πρέπει να γίνεται κάθε φορά όταν το όνομα της συσκευής αλλάξει στην εφαρμογή.

ΕΝΤΟΛΕΣ ΣΤΗΝ ALEXA

Τώρα μπορείτε να ελέγχετε την έξυπνη συσκευή σας, χρησιμοποιώντας τις ηχητικές εντολές της Αλέξα. Παρακάτω θα δείτε μερικές από τις εντολές που μπορείτε να χρησιμοποιήσετε:

- ! *Alexa, turn on/off bedroom light.*
- ! *Alexa, set bedroom light to 50 percent.*
- ! *Alexa, set bedroom light to green.*
- ! *Alexa, set bedroom light to warm white.*

ΤΑ ΠΡΑΓΜΑΤΑ ΤΑ ΟΠΟΙΑ ΠΡΕΠΕΙ ΝΑ ΘΥΜΑΣΤΕ ΠΡΟΤΟΥ ΑΡΧΙΣΕΤΕ ΤΗΝ ΕΓΚΑΤΑΣΤΑΣΗ:

1. Εφαρμογή "V-TAC Smart Light" και "Amazon Alexa".
2. Βεβαιωθείτε ότι διαθέτετε τη συσκευή "Amazon Alexa" (συμπεριλαμβανομένου του Echo, Echo Tap ή του Echo Dot).
3. Έξυπνη συσκευή.
4. Σταθερό Wi-Fi δίκτυο

ΡΥΘΜΙΣΕΙΣ ΤΟΥ GOOGLE HOME

Βήμα 1:

a) και b) Τοποθετήστε την εφαρμογή "Amazon Alexa" μέσω του App Store (iOS) ή του Play Store (Android) και εγγραφείτε. Αν είχατε από πριν ένα προφίλ με Amazon Alexa, παρακαλώ μπείτε σε αυτό.

c) Δημιουργήστε νέο σπίτι/ επιλέξτε ένα από τα υπάρχοντα σπίτια, αν υπάρχει τέτοιο.

d) Συνδέστε στην ηλεκτροδότηση τη συσκευή "Google Home" και συνδέστε τη με την εφαρμογή. (Μετά συνεχίστε προς το Βήμα 2).

a. Welcome home

Your content and devices all in one place



b. Choose account

This account will be used to personalize your experience

c. Choose a home

You will be able to control the devices and services in this home.



d. Plug in your device

Make sure your device is nearby and connected to power, then try again

+ Create another home

GET STARTED >

Βήμα 2: Αφού βρίσκεστε στη σελίδα "Google Home", πιάστε την απεικόνιση "+" – για να προσθέσετε νέα συσκευή και ικανότητα. Στη συνέχεια πατήστε το κουμπί "Ρύθμιση της συσκευής", όπως δείχνουμε στην απεικόνιση παρακάτω.

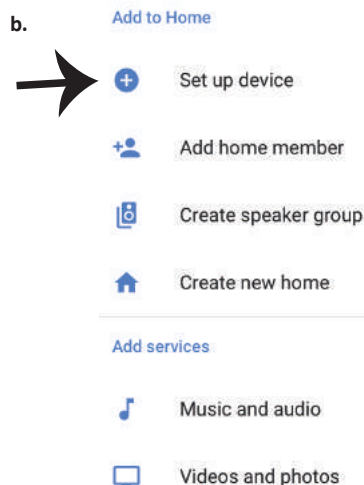
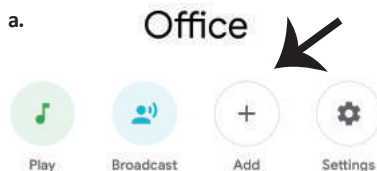

Βήμα 7:

- a. Το προφίλ θα συνδεθεί, παρακαλώ μείνετε στη σελίδα και σε μερικά δευτερόλεπτα θα κατευθυνθείτε αλλού, για να επιλέξετε τη συσκευή την οποία θα προσθέσετε στο νέο σας σπίτι.
b. Επιλέξτε τη συσκευή και πατήστε Επόμενο (όπως δείχνουμε στην απεικόνιση b).

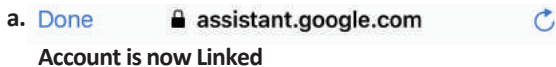

b. ✕ Choose device

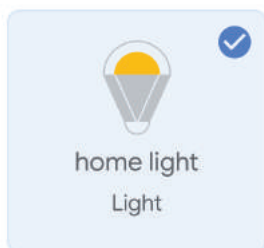

Βήμα 8: Επιλέξτε ως "Σπίτι" το μέρος όπου θέλετε να προσθέσετε τον έξυπνο φωτισμό (ή μπορείτε να δημιουργήσετε "Νέο σπίτι" για να προσθέσετε σε αυτό τον έξυπνο φωτισμό.

Βήμα 9: Εσείς προσθέσατε με επιτυχία τη συσκευή "Έξυπνος φωτισμός" στην εφαρμογή σας "Google Home".

Choose a home

You will be able to control the devices and services in this home.

- Smart-Home
- Office
- Smart Home
- Create another home

Smart-Home ▾



Master bedroom 1 device

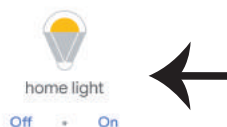

Local devices 1 device



Βήμα 11:

- a. Μπορείτε να ανάψετε/να σβήσετε τη λάμπα με τις σχετικές επιλογές ON/OFF (όπως δείχνουμε στην απεικόνιση α) (H) Μπορείτε να πατήσετε την έξυπνη λάμπα.
 b. Θα σας κατευθύνουν στη σελίδα (όπως δείχνουμε στην απεικόνιση b), όπου μπορείτε να ελέγχετε τα φώτα "Λειτουργία ON και σκοταδιού".

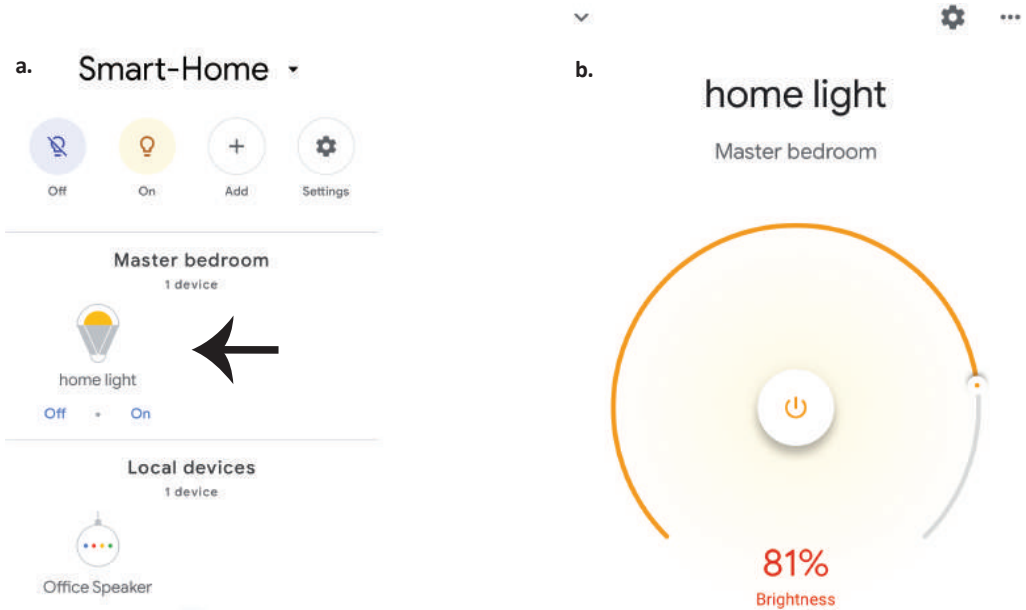
**Εντολές στο Google:**

Τώρα μπορείτε να χειρίζεστε τη δική σας έξυπνη συσκευή, χρησιμοποιώντας τις ηχητικές εντολές του "Google Home". Παρακάτω θα δείτε μερικές εντολές που μπορείτε να χρησιμοποιήσετε

- ! OK Google, turn on/off bedroom light
- ! OK Google, set bedroom light to 50 percent.
- ! OK Google, set bedroom light to green.
- ! OK Google, set bedroom light to warm white.

ΤΙ ΔΕΝ ΠΡΕΠΕΙ ΝΑ ΞΕΧΝΑΜΕ ΠΡΟΤΟΥ ΑΡΧΙΣΟΥΜΕ ΤΗΝ ΤΟΠΟΘΕΤΗΣΗ:

1. Βεβαιωθείτε ότι διαθέτετε το "V-TAC Smart Light" και την Εφαρμογή "Google Home"
2. Βεβαιωθείτε ότι διαθέτετε τη συσκευή „Google Home”.
3. Έξυπνη συσκευή
4. Σταθερό δίκτυο Wi-Fi.

INSTRUKCJA INSTALACJI

- 1) Przed przystąpieniem do montażu należy wyłączyć zasilanie (patrz rys. Część 1).
- 2) Odkręć i zdejmij pokrywę (patrz rys. Część 2).
- 3) Wywierć otwór w suficie, aby przymocować oprawę oświetleniową za pomocą śrub (patrz rys. Część 3).
- 4) Przed przymocowaniem lampy do sufitu za pomocą śrub, podłącz przewody (patrz rys. Część 4).
- 5) Przykręć i zablokuj pokrywę do lampy (patrz rys. Część 5).
- 6) Włącz zasilanie i sprawdź lampę.

OSTRZEŻENIA DOTYCZĄCE BEZPIECZEŃSTWA

- 1) Lampy przeznaczone są wyłącznie do użytku wewnątrz pomieszczeń. Nie należy używać lamp w wilgotnym otoczeniu.
- 2) Na powierzchniach łatwo zapalnych nie wolno montować lamp i latarni.
- 3) Lamp nie należy uderzać ani rzucać na twardą powierzchnię.
- 4) Lampy należy przechowywać w suchym i chłodnym miejscu. Zanim rozpoczniesz instalację lampy upewnij się, że miejsce pracy jest czyste.
- 5) Zużytych lamp nie wolno wyrzucać wraz ze zwykłymi odpadami. Lampy zawierają elementy elektroniczne, należy je wyrzucać do specjalnych pojemników celem ochrony środowiska.

APP INSTALACJA

Krok 1: Zeskanuj podany kod QR lub pobierz „V-TAC Inteligentne oświetlenie” z App Store (iOS) lub „Google Play Store” (Android).

For ANDROID



For IOS



Krok 4: Otwórz aplikację Smart Light V-TAC i kliknij „Register” (Zarejestruj), aby utworzyć nowe konto.

V-TAC Smart Light

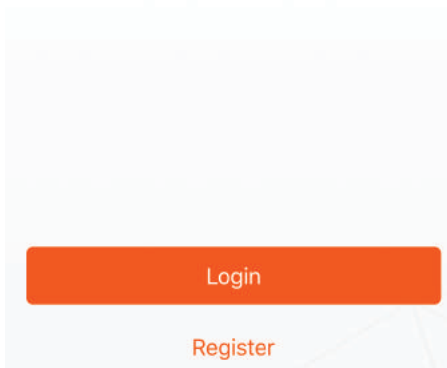

Krok 5:

A) Numer telefonu komórkowego: Wybierz swój kraj i wprowadź numer telefonu komórkowego. Następnie naciśnij „Dalej”.

B) E-mail: Wprowadź adres e-mail i naciśnij „Next” („Dalej”).

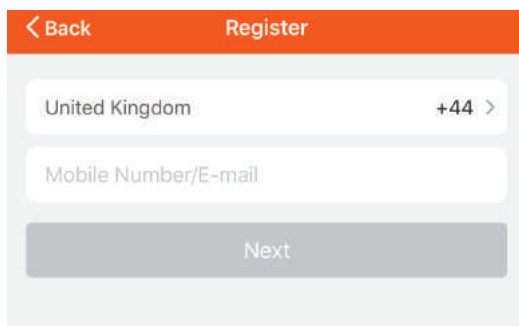

Krok 6: Wprowadź kod weryfikacyjny, który zostanie wysłany na telefon komórkowy / e-mail, a następnie przypisz nowe hasło do konta i kliknij „Confirm” („Potwierdź”).

Krok 7: Naciśnij „Dodanie urządzenia” lub symbol + . Upewnij się, że lampa jest włączona.

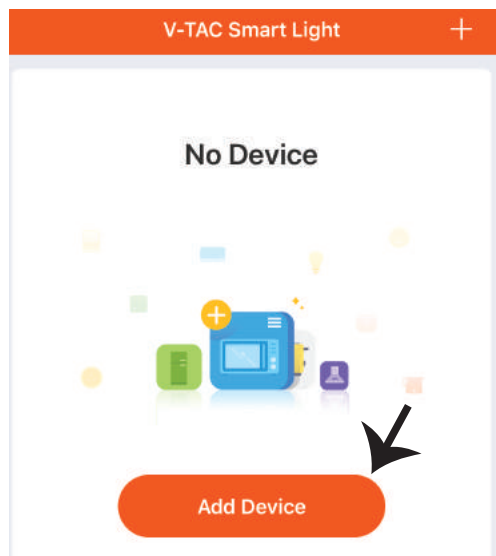
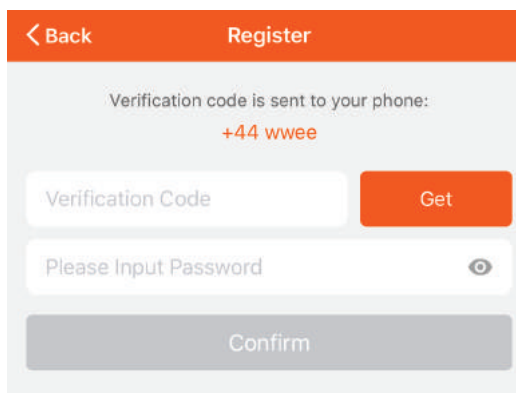

Krok 8: Wybierz „Urządzenie oświetlenia”, aby sparować lampę z aplikacją.

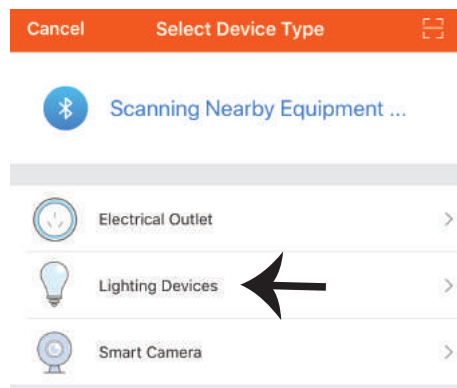

Krok 9: Upewnij się, że lampa została sparowana z urządzeniem – dowodem tego jest szybko migające światło.

Gdy lampka zacznie migać szybko, znajduje się ona w trybie połączenia. Jeśli żarówka nie zacznie migać szybko, możesz wykonać jeden z następujących kroków:

- A. Włączyć i wyłączyć żarówkę 3 razy z przerwami o długości mniejszej niż 2 sekundy.
- B. Nacisnąć link „Co zrobić, żeby lampa zaczęła szybko migać” (jak wskazano na rysunku).

Tryby sieci:

- 1) EZ tryb: Światło miga dwa razy na sekundę.
- 2) AP tryb: Światło miga co 2 sekundy.

Na stronie „Dodanie urządzenia”, sprawdź czy żarówka jest w trybie EZ. Jeśli nie jest, możesz przełączyć w tryb EZ, włączając urządzenie trzy razy.

Sprawdź czy lampa miga szybko, wybierz sieć WiFi i wprowadź hasło.

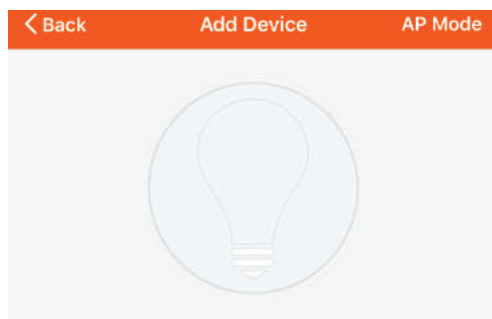
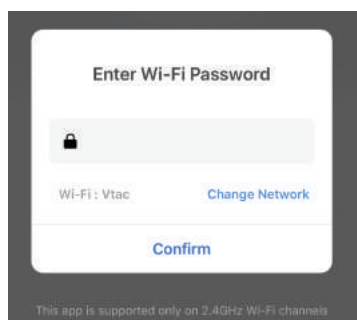

Power on the light and confirm that light blinks rapidly

[How to make light blinks rapidly](#)

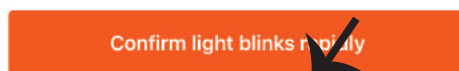

Krok 10: Po pomyślnym zakończeniu kroku 9 zostaniesz przekierowany na dolną stronę, na której aplikacja wyszukuje, rejestruje i inicjalizuje urządzenie (lampę) (patrz rysunek poniżej).

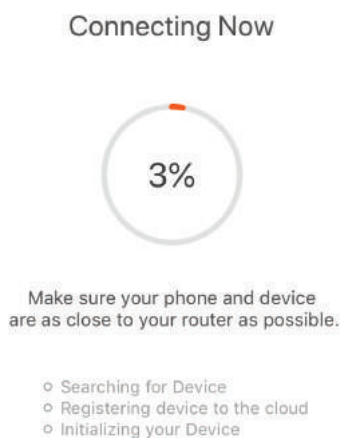

Krok 11: Po udanym dodaniu urządzenia, zmień nazwę urządzenia.

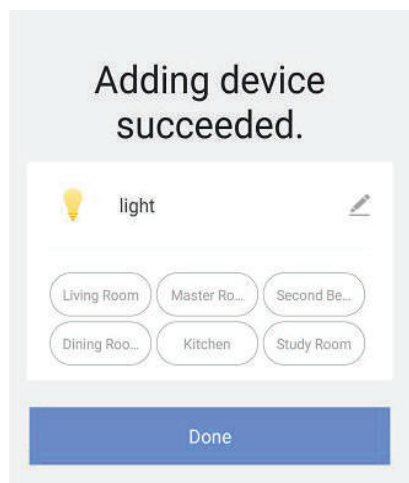

Krok 12: Po pomyślnym podłączeniu lampy do aplikacji można za pomocą telefonu komórkowego zarządzać różnymi funkcjami lampy, tj. włączanie / wyłączenie, temperatura kolorów, synchronizacja i harmonogramy, opcje ściemniania i wiele innych.

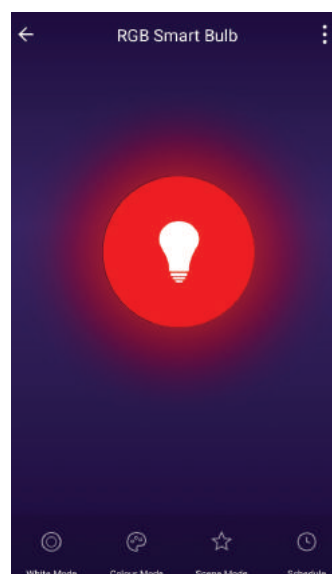
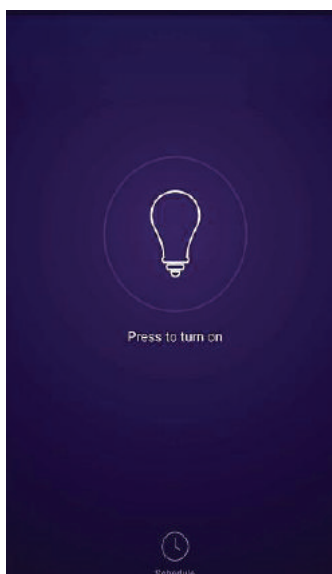
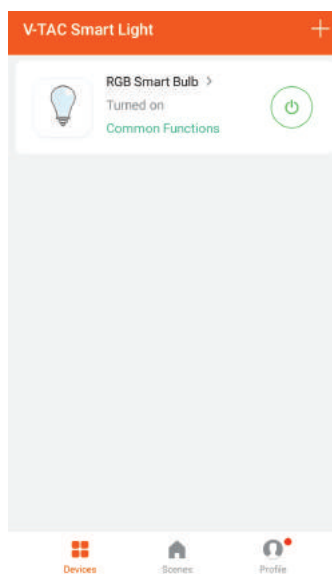

USTAWIENIA ALEXA

Krok 1: Zainstaluj aplikację "Amazon Alexa" za pomocą sklepu App Store (iOS) lub za pomocą "Play Store" (Android), zarejestruj się. Jeśli masz profil w Amazon Alexa, proszę wejść na swój profil.

Krok 3: Naciśnij  Settings (Ustawienia) i potem "Skills & games" („Umiejętności i gry”), jak pokazano poniżej.

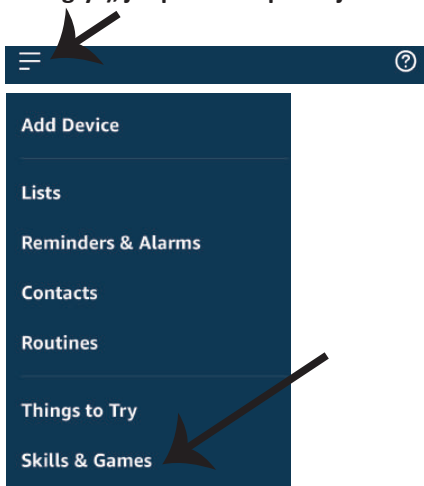

Krok 2: Jeśli jesteś na stronie początkowej aplikacji Amazon Alexa, naciśnij ikonę w prawym, dolnym rogu aby dodać nowe urządzenie i włączyć umiejętności.

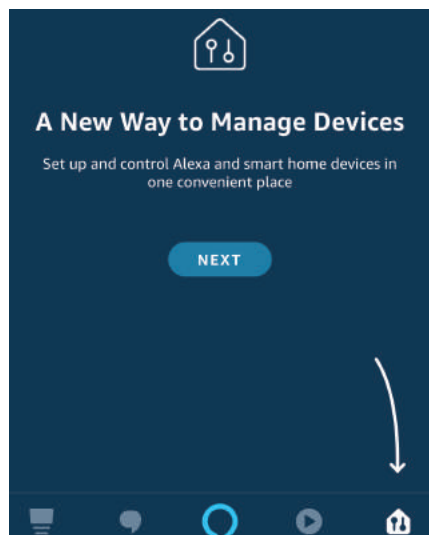

Krok 4: Poszukaj „V-TAC Smart Light” na stronie "Skills & Games", jak pokazano poniżej.

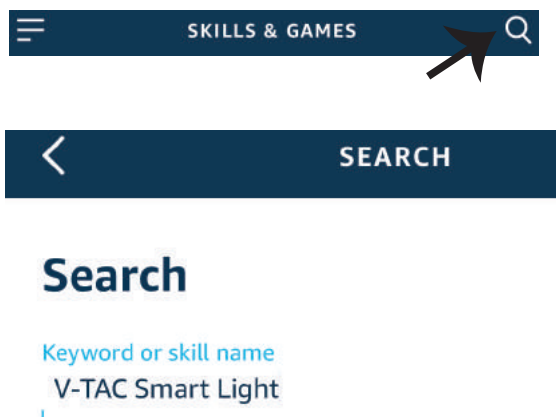

Krok 5: Włącz Umiejętność.

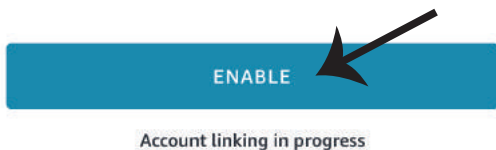

Krok 7: Po kliknięciu Link Now zostaniesz przekierowany na nową stronę, która wymaga autoryzacji (patrz rysunek poniżej). Naciśnij "Authorize" („Autoryzacja”).



Alexa by Amazon will be able to:

Receive your public profile
Control your devices over internet



Krok 6: Wprowadź nazwę użytkownika i hasło V-TAC Smart Light i kliknij „Link Now”.

[Forgot Password](#)

[Help](#)

Krok 8: Otrzymasz potwierdzenie pomyślnie połączonego konta (patrz rysunek poniżej).

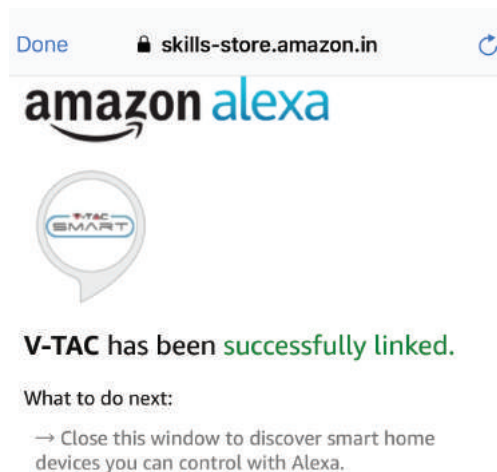

Krok 9: Odkryj swoje inteligentne urządzenie Alexa. Po wybraniu opcji tej

A) Możesz podać rozkaz głosowy "Alexa discover devices" do swojego urządzenia Alexa.

B) Aby dodać urządzenie ręcznie, na stronie głównej naciśnij  a następnie Add device (Dodaj urządzenie), wybierz urządzenie, które chcesz dodać, i naciśnij Discover device (Odkryj urządzenie).

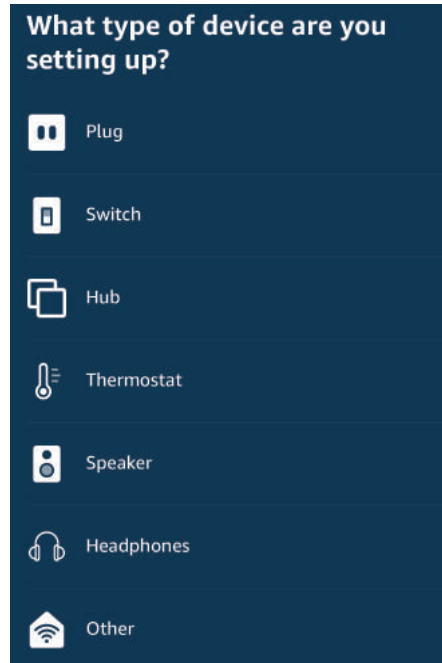
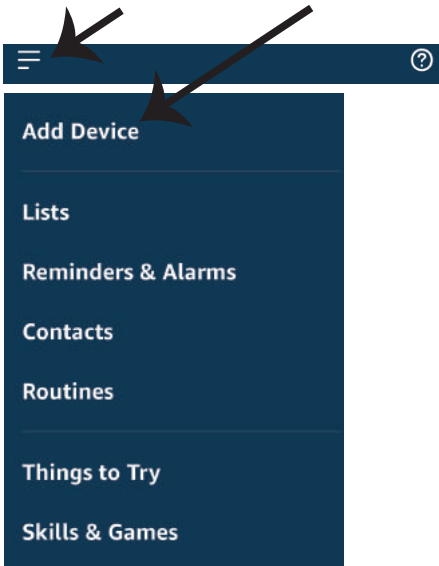

Adnotacja: Znajdź Swoje inteligentne urządzenie w Alexa po każdej zmianie jego nazwy.

KOMENDY ALEXA

Teraz możesz kontrolować Swoje inteligentne urządzenie korzystając z komend głosowych Alexa. Poniżej podano przykłady komend, z których możesz skorzystać:

- ! *Alexa, turn on/off bedroom light.*
- ! *Alexa, set bedroom light to 50 percent.*
- ! *Alexa, set bedroom light to green.*
- ! *Alexa, set bedroom light to warm white.*

RZECZY O KTÓRYCH MUSISZ PAMIĘTAĆ PRZED PRZYSTĄPIENIEM DO INSTALACJI:

1. Aplikacja "V-TAC Smart Light aplikacja "Amazon Alexa"
2. Upewnij się, że masz urządzenie "Amazon Alexa" (włącznie Echo, Echo Tap lub Echo Dot)
3. Inteligentne urządzenie
4. Stabilna sieć WIFI

USTAWIENIA GOOGLE HOME

Krok 1:

a & b) Zainstaluj aplikację Google Home za pomocą App Store (iOS) lub za pomocą Play Store (Android), zarejestruj się. Jeśli masz profil w Google Home, proszę przejdź do logowania.

c) Stwórz nowy dom/wybierz istniejący dom.

d) Włącz urządzenie Google Home i połącz go z aplikacją. (Potem przejdź do kroku 2)

a. Welcome home

Your content and devices all in one place



GET STARTED >

b. Choose account

This account will be used to personalize your experience

c. Choose a home

You will be able to control the devices and services in this home.



+ Create another home

d. Plug in your device

Make sure your device is nearby and connected to power, then try again

Krok 2: Jeśli jesteś na stronie początkowej Google, naciśnij ikonę dodania "+" – aby dodać nowe urządzenie i umiejętność. Naciśnij potem "Ustawienie urządzenia", jak wskazano na rysunku poniżej.

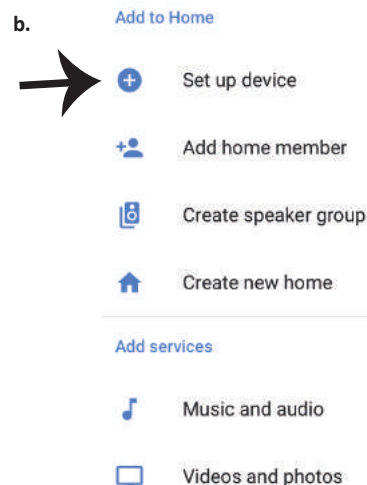
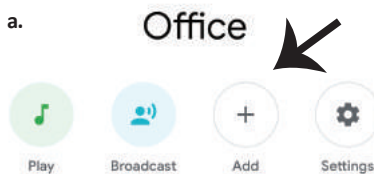

Krok 3: Przed przystąpieniem do kroku 3, upewnij się, że "Inteligentna żarówka" została sparowana z aplikacją "V-TAC Inteligentne oświetlenie". Naciśnij na segment strzałki, jak wskazano na rysunku poniżej.

Set up

Set up new devices or add existing devices and services to your home



New devices

 **Set up new devices**
Google Home, smart displays and devices labelled 'Made for Google' such as C by GE smart bulbs

Works with Google

 **Have something already set up?** 
Link your smart home services such as Philips Hue and TP-Link

Krok 5: Załoguj się w "V-TAC Inteligentne oświetlenie", aby podłączyć urządzenie "Inteligentne oświetlenie".

 +1  Phone Number/Email Address

Type your password here 

Link Now

[Forgot Password](#) [Help](#)

Krok 4: Wpisz „V-TAC Smart Light” w pasku wyszukiwania i naciśnij ikonę „V-TAC Smart Light”.



Krok 6: Wybierz "V-TAC Inteligentne oświetlenie", jak wskazano poniżej, naciśnij "Połączanie teraz".



Google will be able to:
Receive your public profile
Control your devices over internet



Krok 7:

- a. Profil będzie połączony, proszę pozostać na stronie, za kilka sekund zostaniesz przekierowany aby wybrać urządzenie do dodania do Twojego domu.
- b. Wybierz urządzenie i naciśnij „Dalej” (jak wskazano na rysunku b).

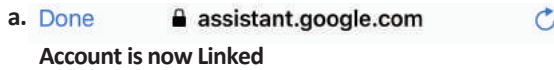



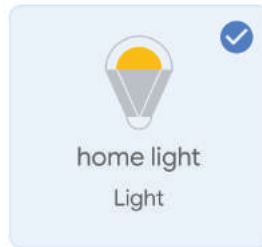

b.  Choose device



Krok 8: Wybierz „Dom”, do którego chcesz dodać Inteligentne oświetlenie. (LUB) Możesz stworzyć „Nowy dom”, aby dodać do niego Inteligentne oświetlenie.

Choose a home

You will be able to control the devices and services in this home.

-  Smart-Home
-  Office
-  Smart Home
-  Create another home

Krok 9: Udane dodanie urządzenia „Inteligentne oświetlenie” do Twojej aplikacji „Google Home”.

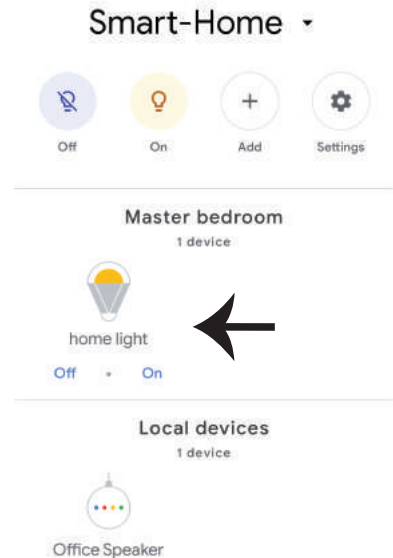

Krok 11:

- a. Możesz włączyć/wyłączyć lampę, naciskając opcje włączyć/wyłączyć (jak wskazano na rysunku a). (LUB) Możesz nacisnąć „Inteligentna lampa”.
- b. Będziesz przekierowany na stronę (jak wskazano na rysunku b), z której możesz kontrolować światła „Funkcja ściemnienie i wzmocnienie”.

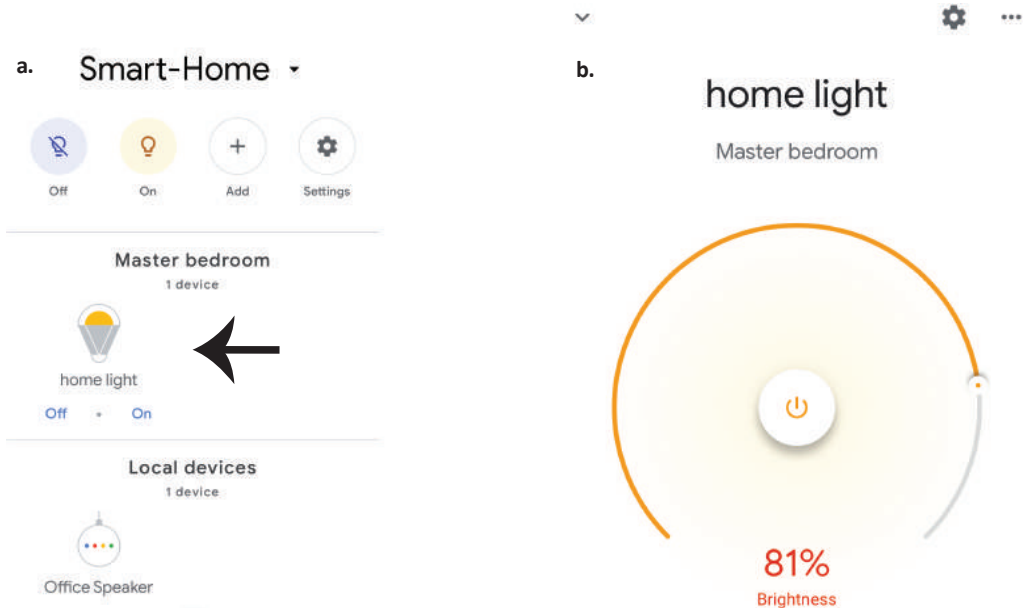
**Komendy Google:**

Teraz możesz kontrolować Swoje inteligentne urządzenie korzystając z komend głosowych Google Home. Poniżej podano przykłady komend, z których możesz skorzystać:

- ! *OK Google, turn on/off bedroom light*
- ! *OK Google, set bedroom light to 50 percent.*
- ! *OK Google, set bedroom light to green.*
- ! *OK Google, set bedroom light to warm white.*

RZECZY O KTÓRYCH MUSISZ PAMIĘTAĆ PRZED PRZYSTĄPIENIEM DO INSTALACJI:

1. Aplikacja „V-TAC Smart Light” & aplikacja „Google Home”
2. Upewnij się, że masz urządzenie „Google Home”
3. Inteligentne Urządzenie
4. Stabilna sieć WiFi

INSTRUCȚIUNI DE INSTALARE

- 1) Înainte să începeți montarea produsului, deconectați alimentarea cu energie electrică (vezi figura - Partea 1).
- 2) Scoateți capacul prin rotire (vezi figura - Partea 2).
- 3) Faceți în tavan un orificiu ca să fixați lampa cu ajutorul șuruburilor (vezi figura - Partea 3).
- 4) Conectați cablurile (vezi figura - Partea 4), înainte să fixați lampa pe tavan cu ajutorul șuruburilor.
- 5) Rotiți capacul lămpii până când blochează, ceea ce înseamnă că e prins bine de lampă (vezi figura - Partea 5)
- 6) Conectați alimentarea cu electricitate și încercați dacă se va aprinde lampa.

AVERTIZĂRI PRIVIND SIGURANȚA

- 1) Utilizare limitată a lămpilor – numai la interior, și nu se recomandă folosirea acestora într-un mediu umed.
- 2) Lămpile și felinarele nu pot fi instalate pe suprafețe din material obișnuit, inflamabil. De obicei, aceste lămpi cresc temperatura aerului.
- 3) Nu exercitați forță externă asupra lămpii și nu o aruncați.
- 4) Lămpile trebuie păstrate la loc răcoros /uscăt. De fiecare dată, înainte să începeți instalarea lămpii, asigurați-vă că veți face acest lucru într-un mediu curat.
- 5) Nu aruncați lampa uzată împreună cu deșeurile menajere. Aceste lămpi sunt confecționate din componente electronice și trebuie depuse la locurile amenajate special pentru tratarea echipamentelor electronice uzate.

APP INSTALAREA

Pasul 1: Scanați codul QR sau descărcați-vă „V-TAC Smart Light” de la App Store (iOS) sau de la „Google Play Store” (Android).

For ANDROID



For IOS



Pasul 4: Deschideți aplicația V-TAC Smart Light și faceți clic pe Register (înregistrare) pentru a crea un cont nou.

V-TAC Smart Light

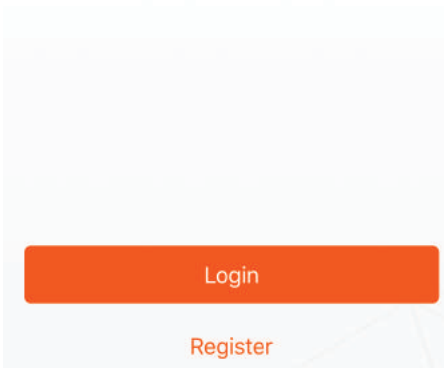

Pasul 5:

A) Număr mobil: Selectați țara și introduceți un număr de telefon mobil. Apoi apăsați "Next".

B) Poștă electronică: Introduceți adresa dvs. de e-mail și faceți clic pe "Next".

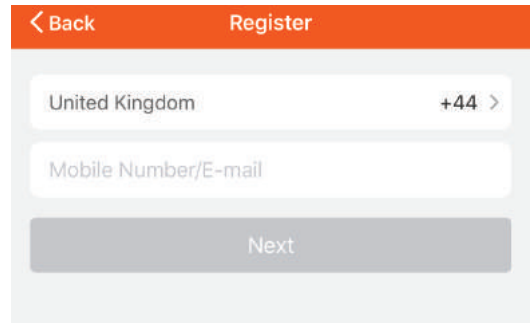

Pasul 6: Introduceți codul de verificare care va fi trimis la telefonul mobil/e-mail, apoi atribuiți o nouă parolă contului dvs. și dați clic pe "Confirm".

Pasul 7: Apăsați pe opțiunea „Aduagă dispozitiv” sau pe simbolul +. Asigurați-vă că lampa a fost conectată.

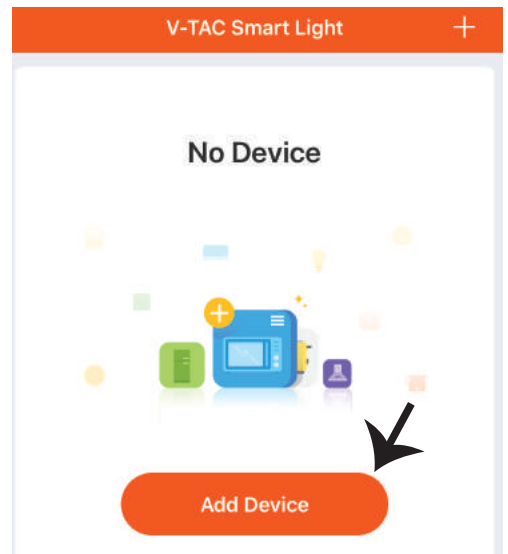
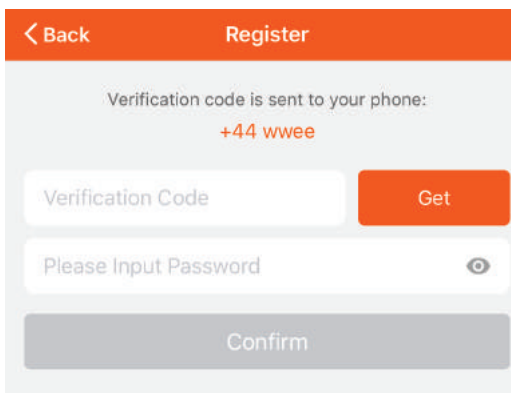

Pasul 8: Selectați „Dispozitive de iluminat” ca să începeți conectarea lămpii la App.

Pasul 9: Pentru conectarea dispozitivului la lampă, asigurați-vă că lampa clipește destul de repede.

După ce lampa începe să clipească rapid, este în modul de conectare. Dacă becul nu clipește rapid, puteți efectua unul din următorii pași

A. Conectați și deconectați becul de 3 ori, la intervale scurte - de sub 2 secunde.

B. Apăsați pe opțiunea „Ce trebuie făcut ca lumina să clipească repede” (așa cum este indicat în figura de mai jos)

Regimul rețelei:

1) Regim EZ: Lumina clipește de două ori pe secundă

2) Regim AP: Clipire încetinită – câte o dată la 2 secunde

Pe pagina „Adăugare dispozitiv”, confirmați dacă becul este în regim EZ. Dacă nu, puteți porni regimul EZ dacă conectați dispozitivul de trei ori.

Confirmați dacă lumina clipește repede, apoi selectați rețeaua WiFi și introduceți parola.

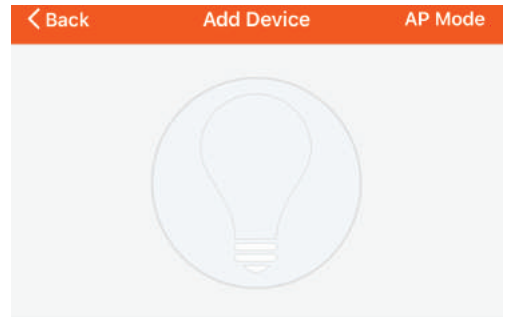
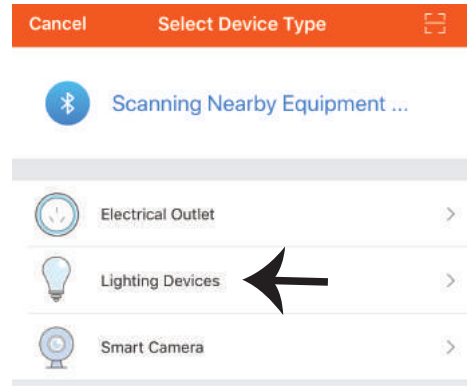
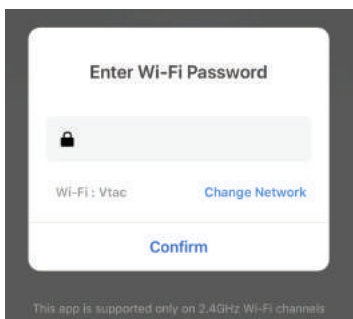

Power on the light and confirm that light blinks rapidly

[How to make light blinks rapidly](#)



Pasul 10: După finalizarea cu succes a pasului 9, veți fi redirecționat către pagina de jos unde aplicația caută, înregistrează și inițiază dispozitivul (lampa) (a se vedea figura de mai jos).

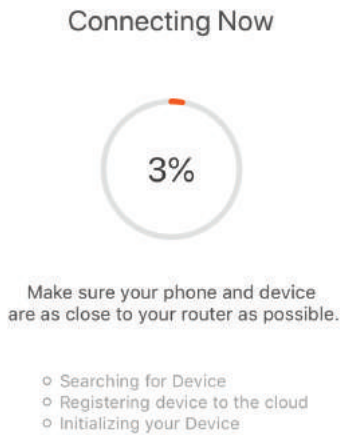

Pasul 11: După ce dispozitivul dvs. a fost adăugat cu succes, schimbați numele dispozitivului în funcție de preferințele dvs.

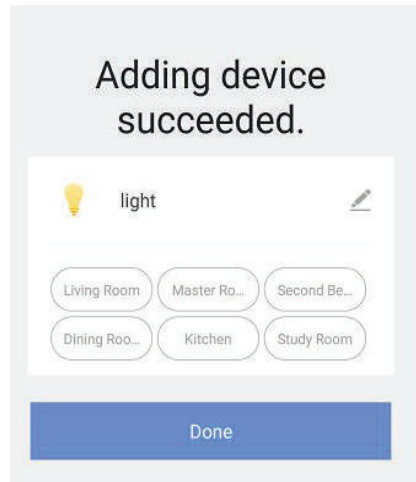

Pasul 12: După ce conectați cu succes lampa la aplicație, puteți gestiona acum o varietate de caracteristici ale lămpii prin telefonul mobil - pornire/oprire, temperatura culorii, sincronizare și temporizare, opțiuni de reglare a luminii și multe altele.

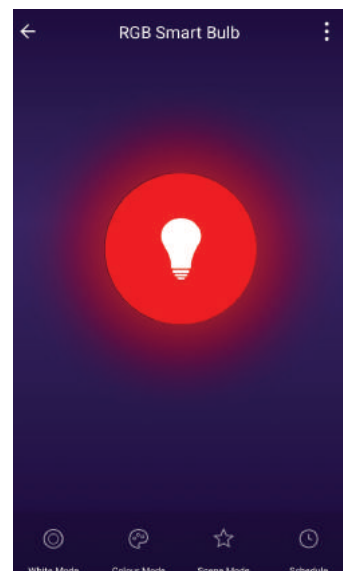
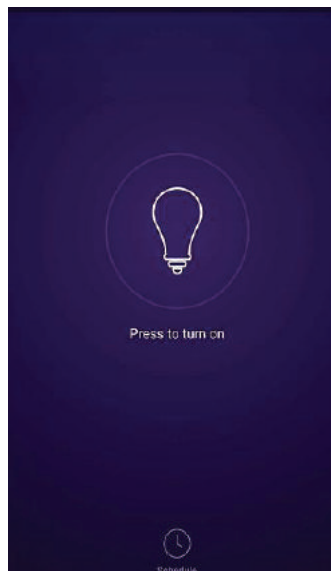
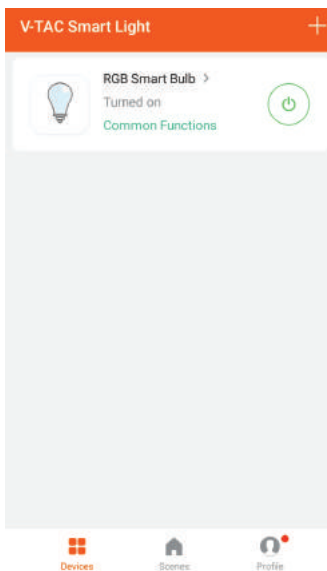

SETĂRI ALEXA

Pasul 1: Instalați plugin-ul "Amazon Alexa" prin App Store (iOS) sau prin Play Store (Android) și înregistrați-vă. Dacă aveți profil în Amazon Alexa, vă rugăm să-l accesați.

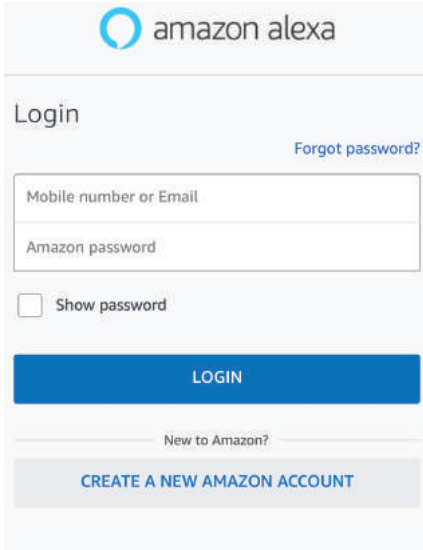

Pasul 3: Apăsați pe  Settings (Setări) și faceți clic pe "Skills & games", după cum se arată mai jos.

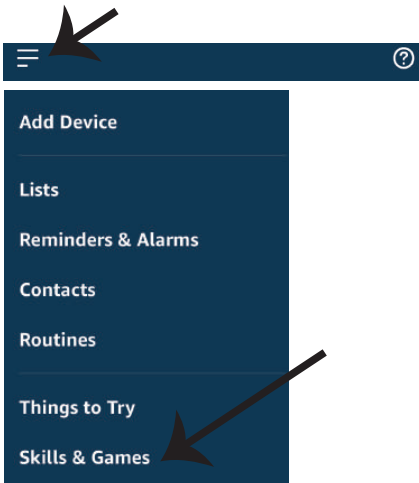

Pasul 2: După ce ați accesat pagina de început din Amazon Alexa, apăsați pe icoana din partea inferioară-dreapta, înspre direcția săgeții, ca să adăugați un dispozitiv nou sau alte opțiuni.

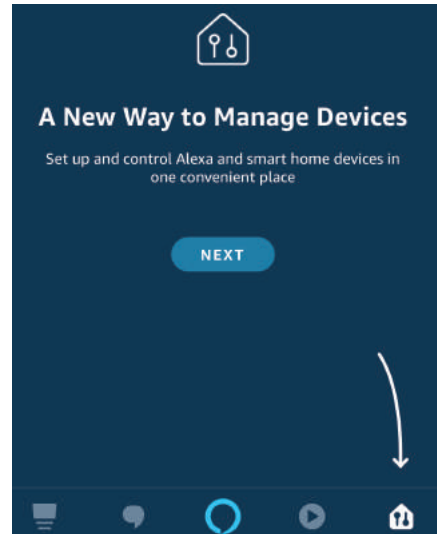

Pasul 4: Căutați "V-TAC Smart Light" pe pagina "Skills & games", după cum se arată mai jos.

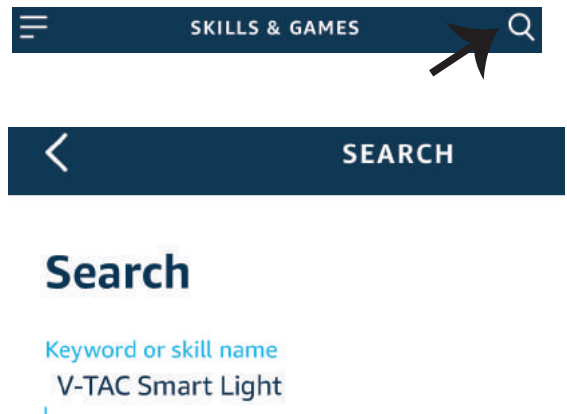

Pasul 5: Permiteți adăugarea abilității.



Pasul 6: Introduceți numele de utilizator și parola pentru conectare în V-TAC Smart Light și faceți clic pe "Link Now".

[Forgot Password](#)

[Help](#)

Pasul 7: După ce faceți clic pe Link Now, veți fi redirecționat către o pagină nouă care necesită autorizare (a se vedea figura de mai jos). Apăsați pe "Authorize".



Alexa by Amazon will be able to:

Receive your public profile
Control your devices over internet



Pasul 8: Veți primi o confirmare a contului conectat cu succes (a se vedea figura de mai jos).



amazon alexa



V-TAC has been **successfully linked**.

What to do next:

→ Close this window to discover smart home devices you can control with Alexa.

Pasul 9: Descoperă smartphone-ul dvs. pe Alexa. Odată ce veți aproba opțiunea,
A) Puteți folosi comanda vocală "Alexa discover devices" către dispozitivul dvs. Alexa.

B) Pentru a adăuga manual un dispozitiv, pe pagina de pornire, apăsați  și apoi Add device, selectați dispozitivul pe care doriți să îl adăugați și apăsați Discover device.

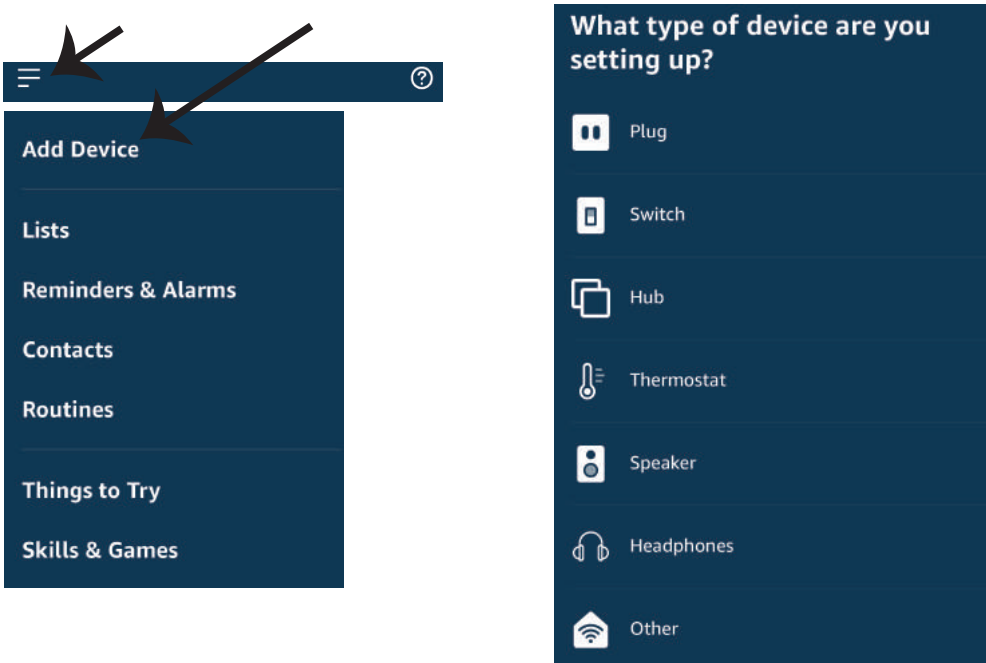

Observație: Descoperirea dispozitivului trebuie făcută de fiecare dată când ați schimbat numele acestuia în App.

COMENZILE DIN ALEXA

Acum deja vă puteți controla dispozitivul inteligent prin folosirea comenzilor vocale în Alexa. Veți vedea mai jos câteva comenzi pe care le puteți folosi:

- ! *Alexa, turn on/off bedroom light.*
- ! *Alexa, set bedroom light to 50 percent.*
- ! *Alexa, set bedroom light to green.*
- ! *Alexa, set bedroom light to warm white.*

LUCRURILE PE CARE TREBUIE SĂ LE REȚINEȚI ÎNAINTE SĂ ÎNCEPEȚI INSTALAREA:

1. App "V-TAC Smart Light" & "Amazon Alexa"
2. Asigurați-vă că dispuneți de dispozitivul "Amazon Alexa" (inclusiv de Echo, Echo Tap sau Echo Dot)
3. Dispozitiv inteligent
4. Rețea stabilă Wifi

SETĂRI GOOGLE HOME

Pasul 1:

a) și b) Instalați app "Google Home" prin App Store (iOS) sau Play Store (Android), înregistrați-vă. Dacă deja dispuneți de profil în "Google Home", vă rugăm să-l accesați.

c) Crearea unui domeniu nou /Selectarea dintre domeniile deja existente, dacă există.

d) Conectați la sursa de alimentare dispozitivul "Google Home" și conectați-l apoi la App. (Apoi continuați cu pasul 2)

a. Welcome home

Your content and devices all in one place



b. Choose account

This account will be used to personalize your experience

d. Plug in your device

Make sure your device is nearby and connected to power, then try again

c. Choose a home

You will be able to control the devices and services in this home.



+ Create another home

GET STARTED >

Pasul 2: După ce ați accesat pagina "Google Home", apăsați icoana Adăugare "+" – ca să adăugați un dispozitiv nou și o abilitate. Apoi apăsați pe "Setare dispozitiv", precum este indicat în figura de mai jos.

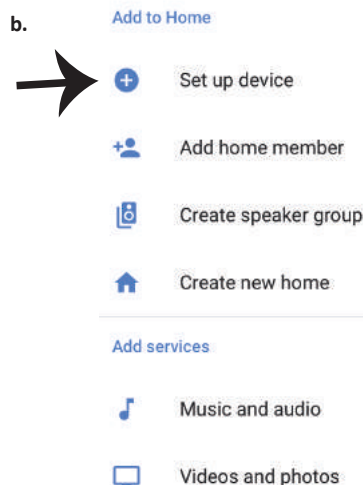
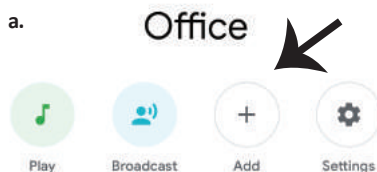

Pasul 3: Asigurați-vă că "Becul inteligent" este conectat la App "V-TAC Smart Light", înainte să treceți la pasul 3. Apăsați pe secțiunea pentru săgeată, precum este indicat în figura de mai jos.

Set up

Set up new devices or add existing devices and services to your home

New devices



Set up new devices

Google Home, smart displays and devices labelled 'Made for Google' such as C by GE smart bulbs

Works with Google



Have something already set up?

Link your smart home services such as Philips Hue and TP-Link

Pasul 5: Cu ajutorul datelor dvs. de acces, intrați în "V-TAC Smart Light" ca să faceți legătură cu dispozitivul inteligent "Iluminare inteligentă".

+ 1 ▼

Link Now

[Forgot Password](#)

[Help](#)

Pasul 4: Introduceți "V-TAC Smart Light" pe bara de căutare și apăsați pictograma "V-TAC Smart Light".



V-TAC Smart Life



Pasul 6: Selectați "V-TAC Smart Light", precum este indicat în figura de mai jos, și apoi apăsați pe "Conectare - acum".



Google will be able to:

Receive your public profile
Control your devices over internet

Authorize



Pasul 8:

- a. Profilul va fi conectat, vă rugăm să rămâneți pe această pagină și după câteva secunde veți fi reorientați ca să vă selectați dispozitivul de adăugat la domeniul dvs.
- b. Selectați dispozitivul și apăsați pe "Următorul" (precum este indicat în figura b).

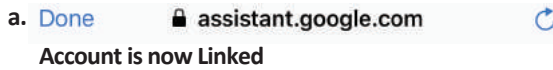

b.  Choose device

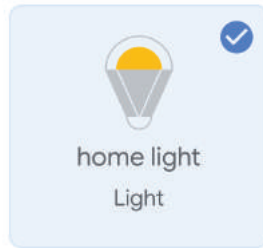





Pasul 9: Selectați "Domeniu", locul unde doriți să adăugați iluminare inteligentă (sau) puteți crea un "Domeniu nou" unde puteți adăuga iluminarea inteligentă.

Pasul 10: Ați adăugat cu succes dispozitivul "Iluminare inteligentă" la App "Google Home".

Choose a home

You will be able to control the devices and services in this home.

-  Smart-Home
-  Office
-  Smart Home
-  Create another home

Smart-Home ▾

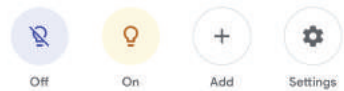

Master bedroom 1 device

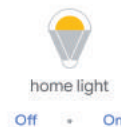

Local devices 1 device



Pasul 11:

a. Vă rugăm să conectați /deconectați lampa prin alegerea opțiunilor conectat/deconectat (precum este indicat în figura a). (SAU) Puteți apăsa pe "lampa inteligentă".

b. Veți fi reorientați către pagina (este indicat în figura b), unde puteți controla luminile "Funcționalitatea conectării și întunecării".

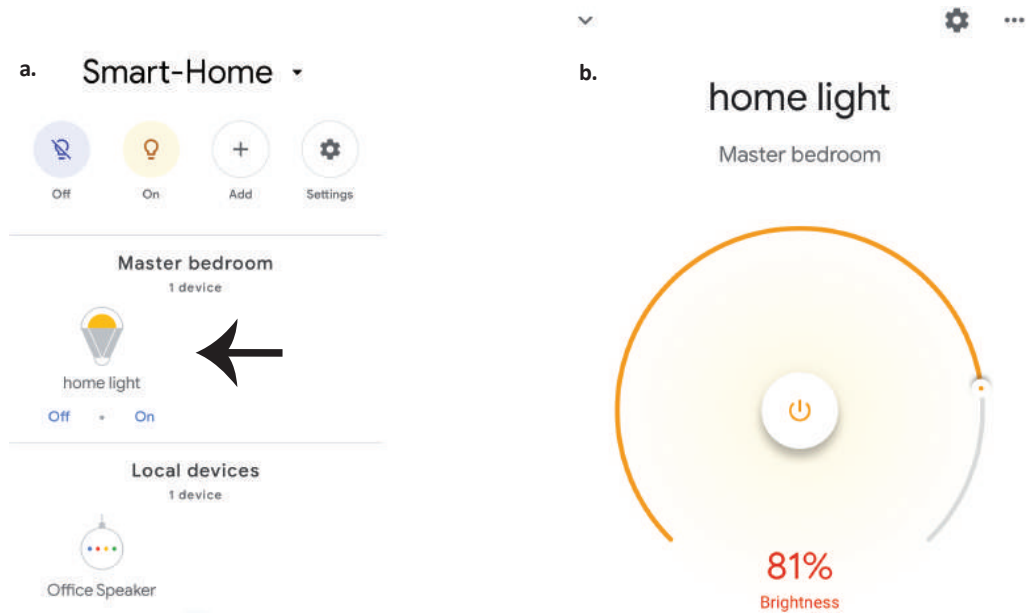
**Comenzile Google:**

Acum deja vă puteți controla dispozitivul inteligent prin folosirea comenzilor vocale în "Google Home". Veți vedea mai jos câteva comenzi pe care le puteți folosi:

- ! *OK Google, turn on/off bedroom light*
- ! *OK Google, set bedroom light to 50 percent.*
- ! *OK Google, set bedroom light to green.*
- ! *OK Google, set bedroom light to warm white.*

CE NU TREBUIE SĂ UITĂM ÎNAINTE SĂ ÎNCEPEM INSTALAREA:

1. App "V-TAC Smart Light" și App "Google Home"
2. Asigurați-vă că dispuneți de dispozitivul "Google Home"
3. Dispozitiv inteligent
4. Rețea stabilă Wifi

POKYNY K MONTÁŽI

- 1) Před zahájením montáže vypněte napájení (viz obrázek Část 1).
- 2) Otočte a odstraňte kryt (viz obrázek Část 2).
- 3) Vyvrtejte otvor do stropu pro upevnění lampy pomocí šroubů (viz obr. Část 3).
- 4) Připojte vodiče (viz obr. Část 4) před upevněním lampy ke stropě pomocí šroubů.
- 5) Otočte a zablokujte kryt k lampě (viz obrázek Část 5).
- 6) Zapněte napájení a otestujte lampu.

OSTRZEŻENIA DOTYCZĄCE BEZPIECZEŃSTWA

- 1) Lampy przeznaczone są wyłącznie do użytku wewnątrz pomieszczeń. Nie należy używać lamp w wilgotnym otoczeniu.
- 2) Na powierzchniach łatwo zapalnych nie wolno montować lamp i latarni.
- 3) Lamp nie należy uderzać ani rzucać na twardą powierzchnię.
- 4) Lampy należy przechowywać w suchym i chłodnym miejscu. Zanim rozpoczniesz instalację lampy upewnij się, że miejsce pracy jest czyste.
- 5) Zużytych lamp nie wolno wyrzucać wraz ze zwykłymi odpadami. Lampy zawierają elementy elektroniczne, należy je wyrzucać do specjalnych pojemników celem ochrony środowiska.

APP INSTALACJA

Krok 1: Zeskanuj podany kod QR lub pobierz „V-TAC Inteligentne oświetlenie” z App Store (iOS) lub „Google Play Store” (Android).

For ANDROID



For IOS



Krok 4: Otevřete aplikaci Vi-Tek (V-TAC) Smart Light - inteligentní světla a stiskněte tlačítko Register (registrace) vytvořit nový účet.

V-TAC Smart Light

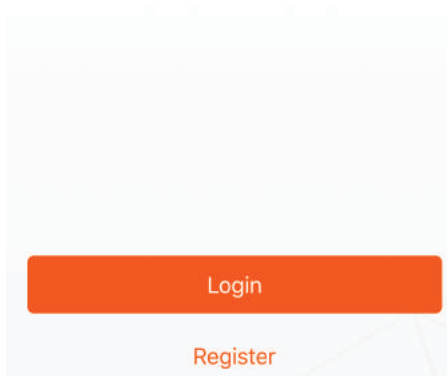

Krok 6: Zadejte ověřovací kód, který bude odeslán do mobilního telefonu / e-mailem, a pak přiřadit nové heslo ke svému účtu a klikněte na tlačítko „Potvrdit“.

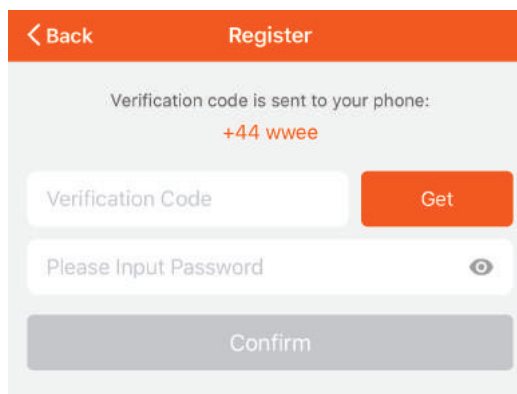

Krok 5:

A) Mobilní číslo: Vyberte svou zemi a zadejte číslo mobilního telefonu. Poté stiskněte 'Další'.
B) E-mail: Zadejte e-mailovou adresu a klikněte na tlačítko 'Další'

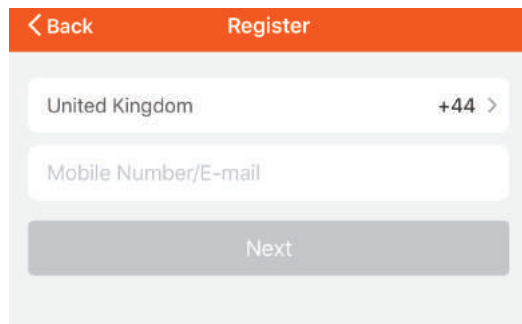

Krok 7: Naciśnij „Dodanie urządzenia” lub symbol + . Upewnij się, że lampa jest włączona.

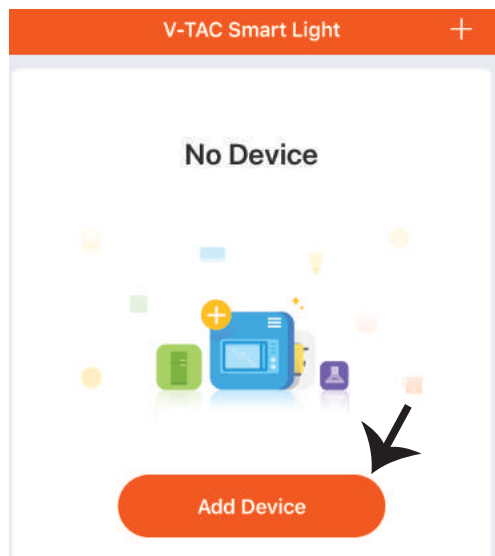

Krok 8: Wybierz „Urządzenie oświetlenia”, aby sparować lampę z aplikacją.

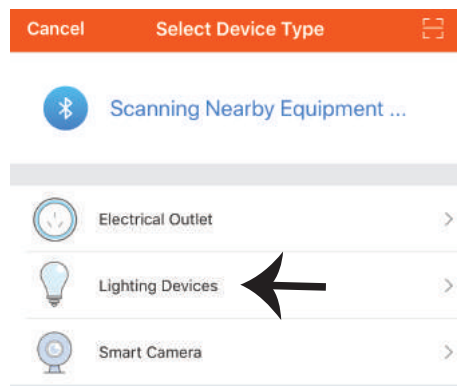

Krok 9: Upewnij się, że lampa została sparowana z urządzeniem – dowodem tego jest szybko migające światło.

Jakmile kontrolka rychle bliká, je v režimu připojení. V případě, že žárovka neblinká rychle, můžete si vzít jednu z následujících kroků:

A. Włączyć i wyłączyć żarówkę 3 razy z przerwami o długości mniejszej niż 2 sekundy.

B. Nacisnąć link „Co zrobić, żeby lampa zaczęła szybko migać” (jak wskazano na rysunku).

Tryby sieci:

1) EZ tryb: Światło miga dwa razy na sekundę.

2) AP tryb: Światło miga co 2 sekundy.

Na stronie „Dodanie urządzenia”, sprawdź czy żarówka jest w trybie EZ. Jeśli nie jest, możesz przełączyć w tryb EZ, włączając urządzenie trzy razy.

Sprawdź czy lampa miga szybko, wybierz sieć WiFi i wprowadź hasło.

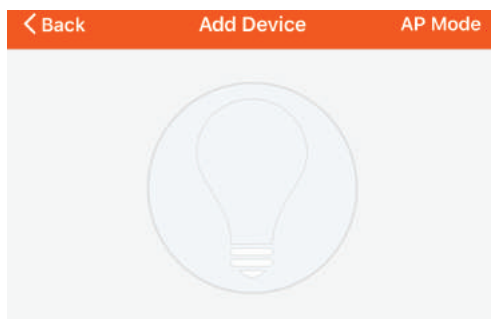
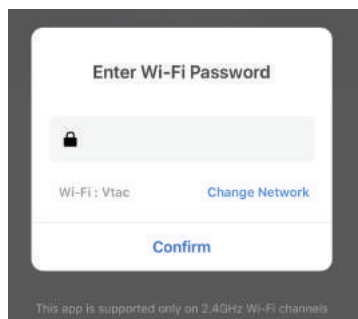

Power on the light and confirm that light blinks rapidly

[How to make light blinks rapidly](#)



Krok 10: Po úspěšném dokončení kroku 9 budete přeměrováni na dolní stránku, kde aplikace vyhledává, registruje a inicializuje zařízení (lampa) (viz obrázek níže).

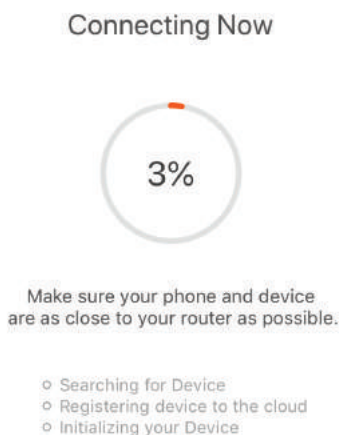

Krok 11: Po udaném dodání urządzenia, zmień nazwę urządzenia.

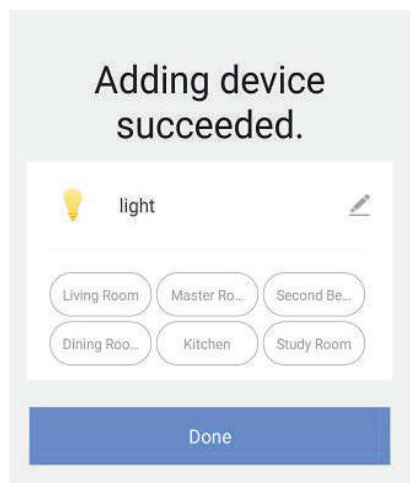

Krok 12: Po udaném sparování žárovky z aplikací můžete ovládat žárovku smartfonem – włączat/wyłączać, zmieniać temperaturę koloru, synchronizować, ściemniać itp.

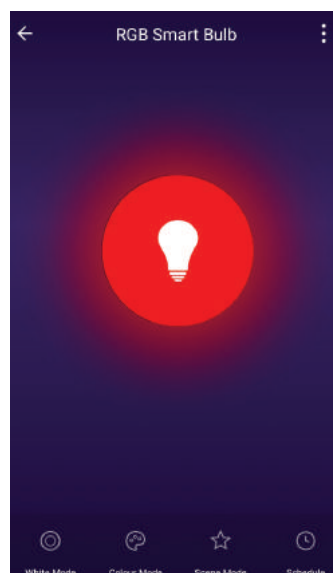
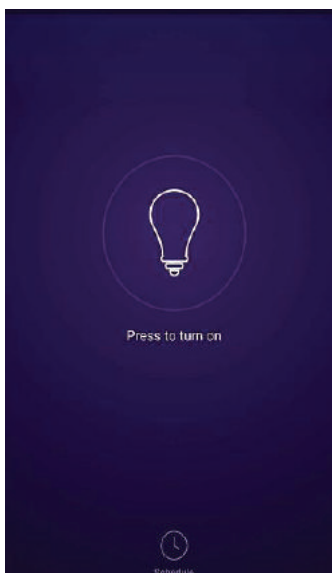
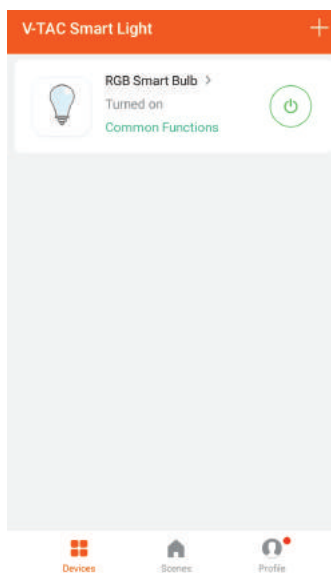

NASTAVENÍ APLIKACE ALEXA

Krok 1: Nainstalujte aplikaci „Amazon Alexa“ z App Store (iOS) nebo z Play Store (Android) a zaregistrujte se. Pokud již máte u Amazonu Alexa svůj účet, přihlaste se prosím do něho.

Krok 3: Klepněte  na nastavení a klepněte na "Dovednosti a hry", jak je uvedeno níže.

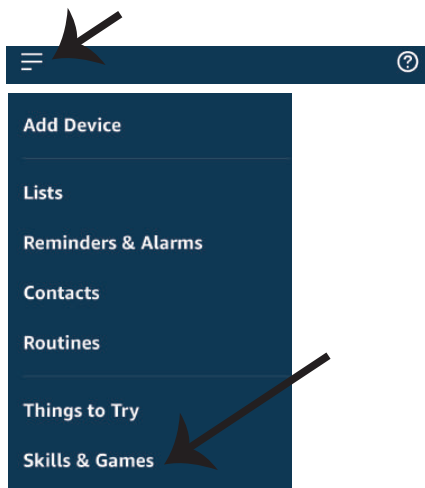

Krok 2: Jakmile jste na domovské stránce Amazon Alexa, klepněte na pravou dolní ikonu – tam, kam ukazuje šipka, – abyste přidali nové zařízení a dovednosti.

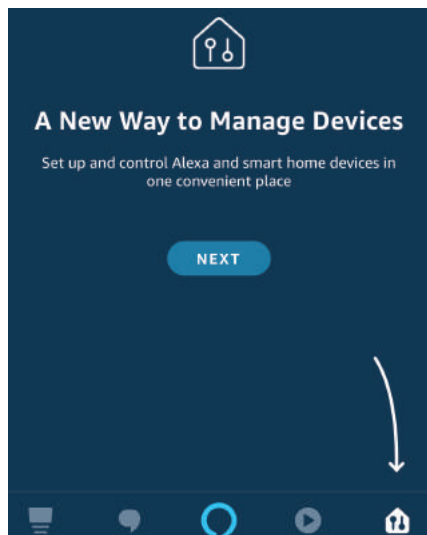

Krok 4: Vyhledejte „Smart Life“ na vyhledávacím panelu stránky „Dovedností a hry“, jak je uvedeno níže.

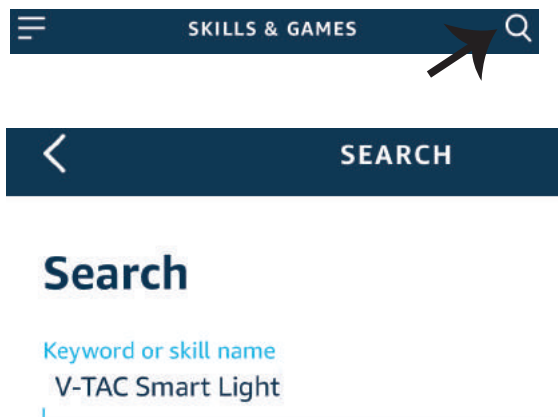

Krok 5: Povolte dovednost.

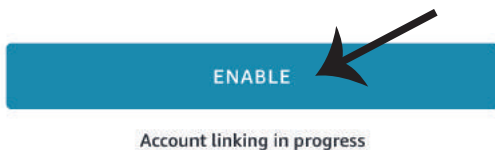

Krok 7: Jakmile kliknete na odkaz Nyní, budete přesměrováni na novou stránku, která vyžaduje autorizaci (viz obrázek níže). Stiskněte "Autorizovat".



Alexa by Amazon will be able to:

Receive your public profile
Control your devices over internet

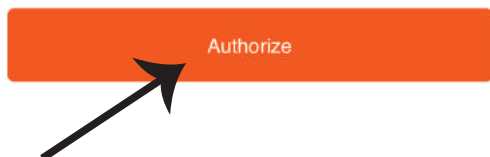

Krok 7: Jakmile kliknete na odkaz Nyní, budete přesměrováni na novou stránku, která vyžaduje autorizaci (viz obrázek níže). Stiskněte "Autorizovat".

[Forgot Password](#)

[Help](#)

Krok 8: Obdržíte potvrzení o úspěšně navázaném účtu (viz obrázek níže).

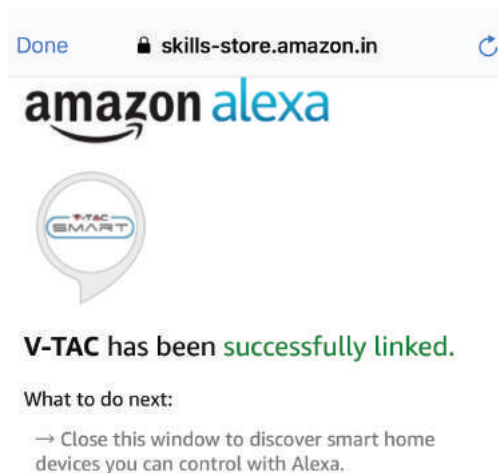

Krok 9: Objevte svůj inteligentní přístroj Alexa. Jakmile máte možnost, A) můžete odeslat hlasový příkaz „Alexa objevit zařízení“ do přístroje Alexa.

B) Chcete-li přidat zařízení ručně, stiskněte na domovské stránce tlačítko  a poté možnost Přidat zařízení, vyberte zařízení, které chcete přidat, a stiskněte tlačítko Zjistit zařízení

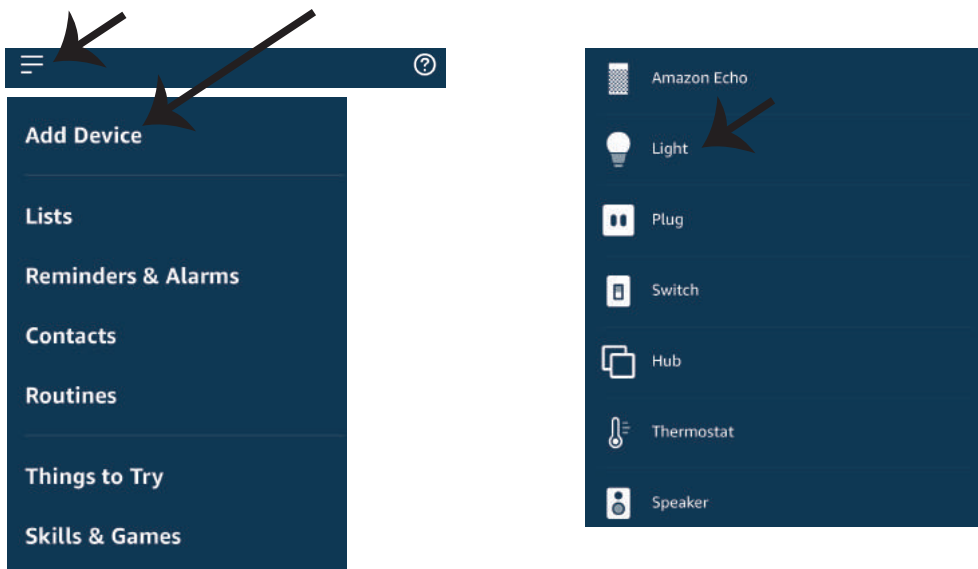

Poznámka: Zařízení musí být vyhledáno znovu při každé změně názvu zařízení v aplikaci.

POVELY APLIKACE ALEXA

Nyní můžete ovládat své inteligentní zařízení pomocí hlasových povelů Alexa. Níže je několik povelů, které můžete použít:

- ! *Alexa, turn on/off bedroom light.*
- ! *Alexa, set bedroom light to 50 percent.*
- ! *Alexa, set bedroom light to green.*
- ! *Alexa, set bedroom light to warm white.*

DOPORUČENÍ PŘED ZAHÁJENÍM INSTALACE:

1. Aplikace „V-TAC Smart Light“ a „Amazon Alexa“
2. Ujistěte se, že máte zařízení „Amazon Alexa“ (včetně Echo, Echo Tap nebo Echo Dot)
3. Inteligentní zařízení
4. Stabilní síť Wifi

NASTAVENÍ GOOGLE HOME

Krok 1: a) a b) Nainstalujte aplikaci „Google Home“ prostřednictvím App Store (iOS) nebo Play Store (Android) a zaregistrujte se. Pokud už máte účet v „Google Home“, přihláste se, prosím, do něho.

c) Vytvořit nového domu/Vybrat existující dům, pokud existuje.

d) Připojte k napájecí síti zařízení Zapněte domácí zařízení Google a připojte jej k aplikaci. (Potom pokračujte krokem 2)

a. Welcome home

Your content and devices all in one place



b. Choose account

This account will be used to personalize your experience

c. Choose a home

You will be able to control the devices and services in this home.



d. Plug in your device

Make sure your device is nearby and connected to power, then try again

+ Create another home

[GET STARTED >](#)

Krok 2: Jakmile jste na stránce „Google Home“, klepnutím na ikonu Přidat „+“ přidáte nové zařízení a dovednost. Potom klepněte na položku „Nastavení zařízení“, jak je znázorněno na obrázku níže.

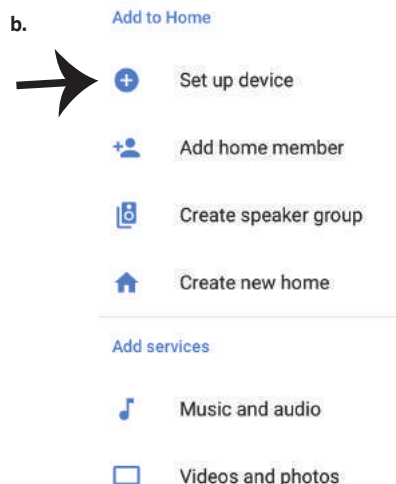
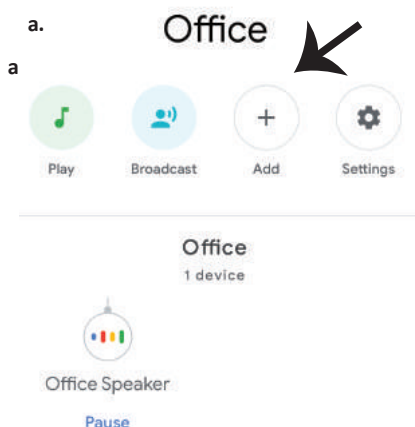

Krok 3: Před spuštěním kroku 3 se ujistěte, zda je chytrá žárovka spárována s aplikací „V-TAC Smart Light“. Klepněte na sekci se šipkami, jak je uvedeno na obrázku níže.



Set up

Set up new devices or add existing devices and services to your home



New devices

 **Set up new devices**
Google Home, smart displays and devices labelled 'Made for Google' such as C by GE smart bulbs

Works with Google

 **Have something already set up?** 
Link your smart home services such as Philips Hue and TP-Link

Krok 5: Přihlaste se svými údaji pro přihlášení do „V-TAC Smart Light“ pro připojení se zařízením „Smart Light“.

 +1  Phone Number/Email Address

Type your password here 

Link Now

[Forgot Password](#)

[Help](#)

Krok 4: Na panelu pro vyhledávání zadejte „Smart Life“ a klepněte na ikonu „Smart Life“, jak je uvedeno níže.

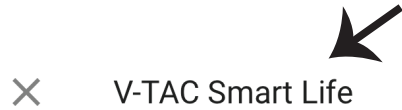

Krok 6: Vyberte „V-TAC Smart Light“, jak je znázorněno níže. a klepněte na odkaz „Propojit“.



Google will be able to:
Receive your public profile
Control your devices over internet



Krok 7:

a. Účet bude nyní propojen, zůstaňte na stránce, během několika vteřin budete přesměrováni, abyste vybrali zařízení, které chcete přidat do svého domu.

b. Vyberte zařízení a klepněte na „Další“ (jako na obrázku v obrázku b).

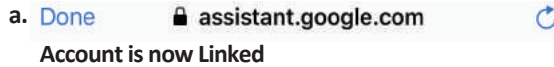

b.  Choose device

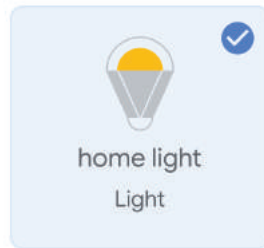





Krok 8: Vyberte „Dům“, místo, kam chcete přidat inteligentní osvětlení. (nebo) můžete vytvořit „Nový dům“, abyste přidali k němu inteligentní osvětlení.

Krok 9: Úspěšně jste přidali zařízení „Smart Light“ do své aplikace „Google Home“.

Choose a home

You will be able to control the devices and services in this home.

-  Smart-Home
-  Office
-  Smart Home
-  Create another home

Smart-Home ▾

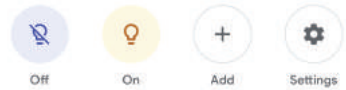
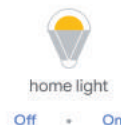
Master bedroom
1 deviceLocal devices
1 device

Krok 10:

- a. Možetez włączyć/wyłączyć lampę, naciskając opcje włączyć/wyłączyć (jak wskazano na rysunku a). (LUB) Možetez naciśnąć „Inteligentna lampa”.
- b. Będziez przekierowany na stronę (jak wskazano na rysunku b), z której možetez kontrolować światła „Funkcja ściemnienie i wzmocnienie”.

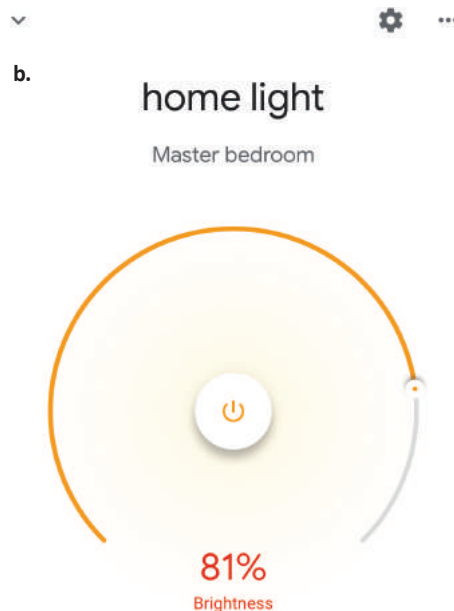
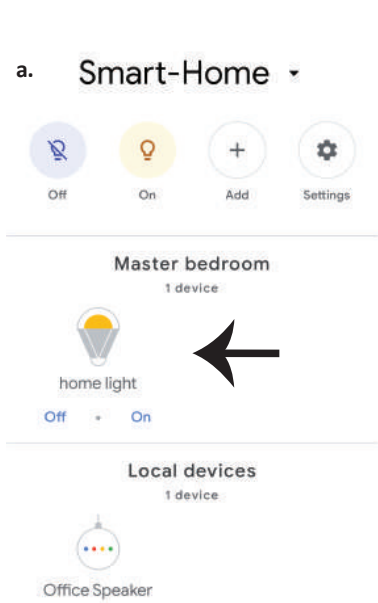
**Povely v Google:**

Nyní můžete ovládat své inteligentní zařízení pomocí hlasových povelů z „Google Home“ Níže je několik povelů, které můžete použít:

- ! *OK Google, turn on/off bedroom light*
- ! *OK Google, set bedroom light to 50 percent.*
- ! *OK Google, set bedroom light to green.*
- ! *OK Google, set bedroom light to warm white.*

DOPORUČENÍ PŘED ZAHÁJENÍM INSTALACE:

1. Aplikace „V-TAC Smart Light“ a aplikace „Google Home“
2. Ujistěte se, že máte zařízení „Google Home“
3. Inteligentní zařízení
4. Stabilní síť Wifi